



# Click

Install-from-below Zero-plenum LED Luminaire

**axis**



# The Shallow Plenum Challenge



 Water Pipe

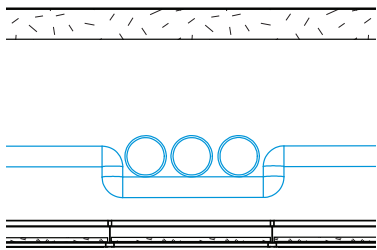

 Sprinkler

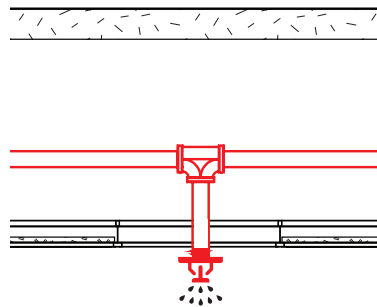

 AC Duct

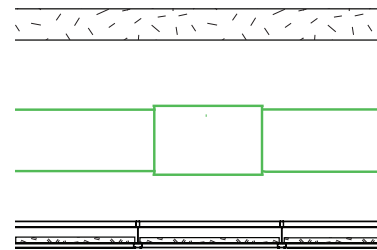

 Shallow Plenum







## Install-from-below Zero-plenum LED Luminaire

As plenum depth shrinks, shallow luminaires like Click are increasingly in demand. With ultra-thin Click, you no longer have to worry about AC ducts and other obstructions in the plenum space. You also benefit from a patent-pending hassle-free installation system.

The product of an exclusive Axis-Armstrong® innovation partnership, Click is the first true install-from-below shallow luminaire, compatible with closed grids, drywall ceilings and Armstrong on-center ceiling systems.

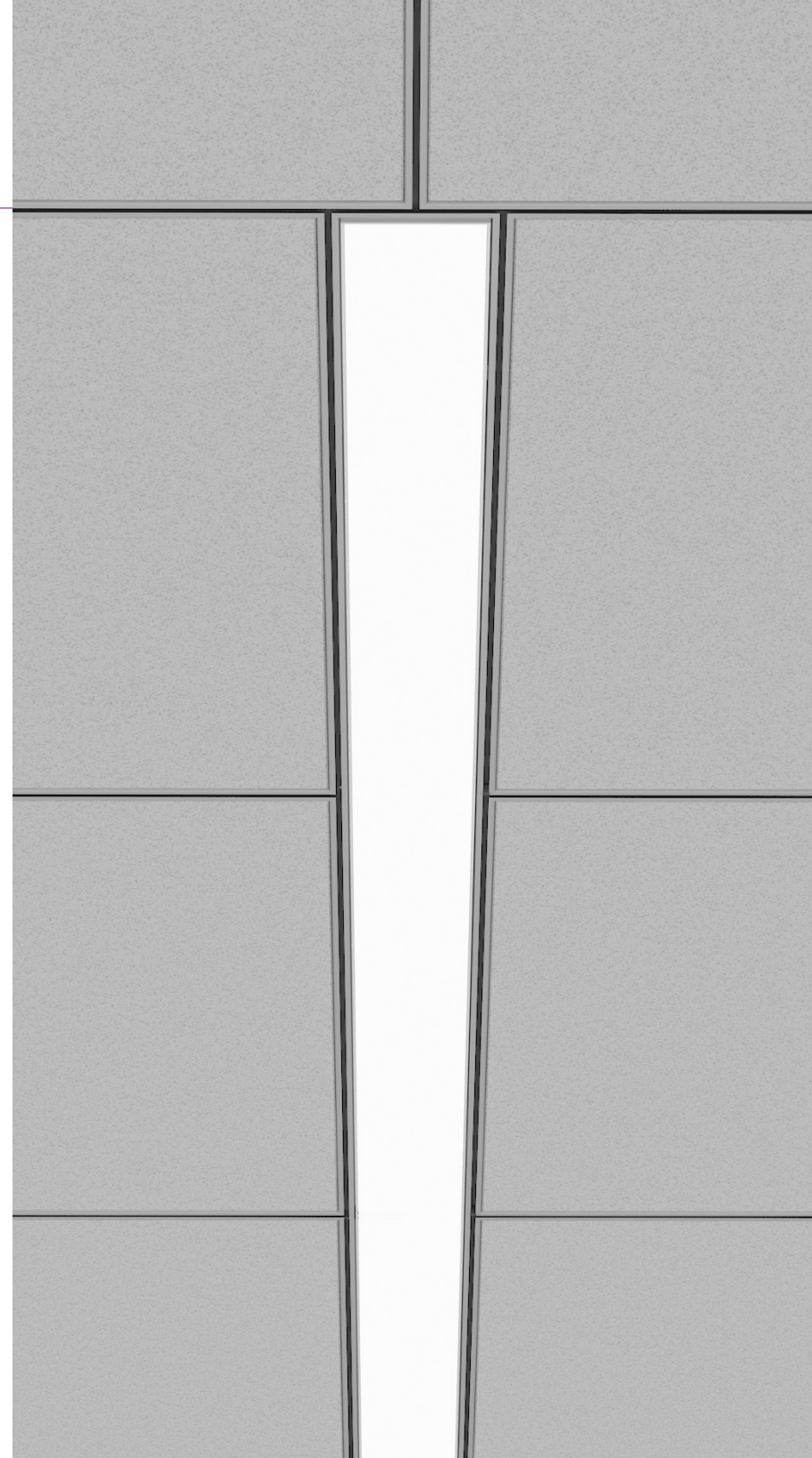

# The future of shallow luminaire design

**Install from above**  
Added plenum space required

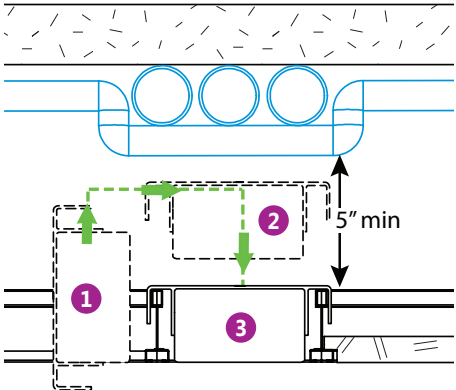

**Partly install from below**  
Access from above required

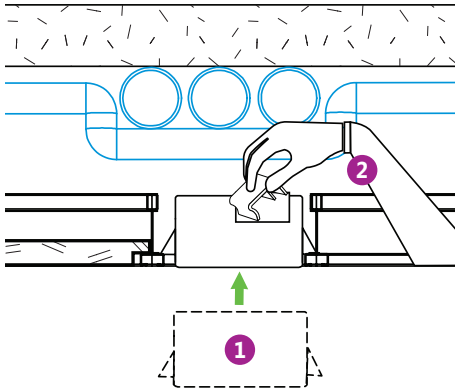

**Truly install from below**

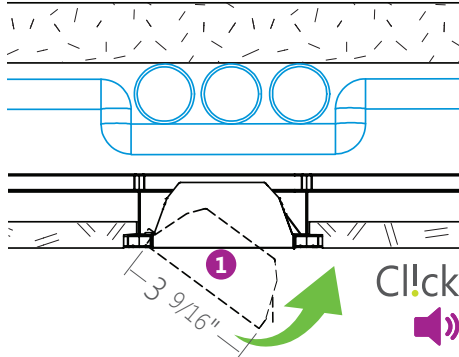

Without  
**Click**

With  
**Click**



# Click. Truly install from below

Compatible with all narrow T-grid systems

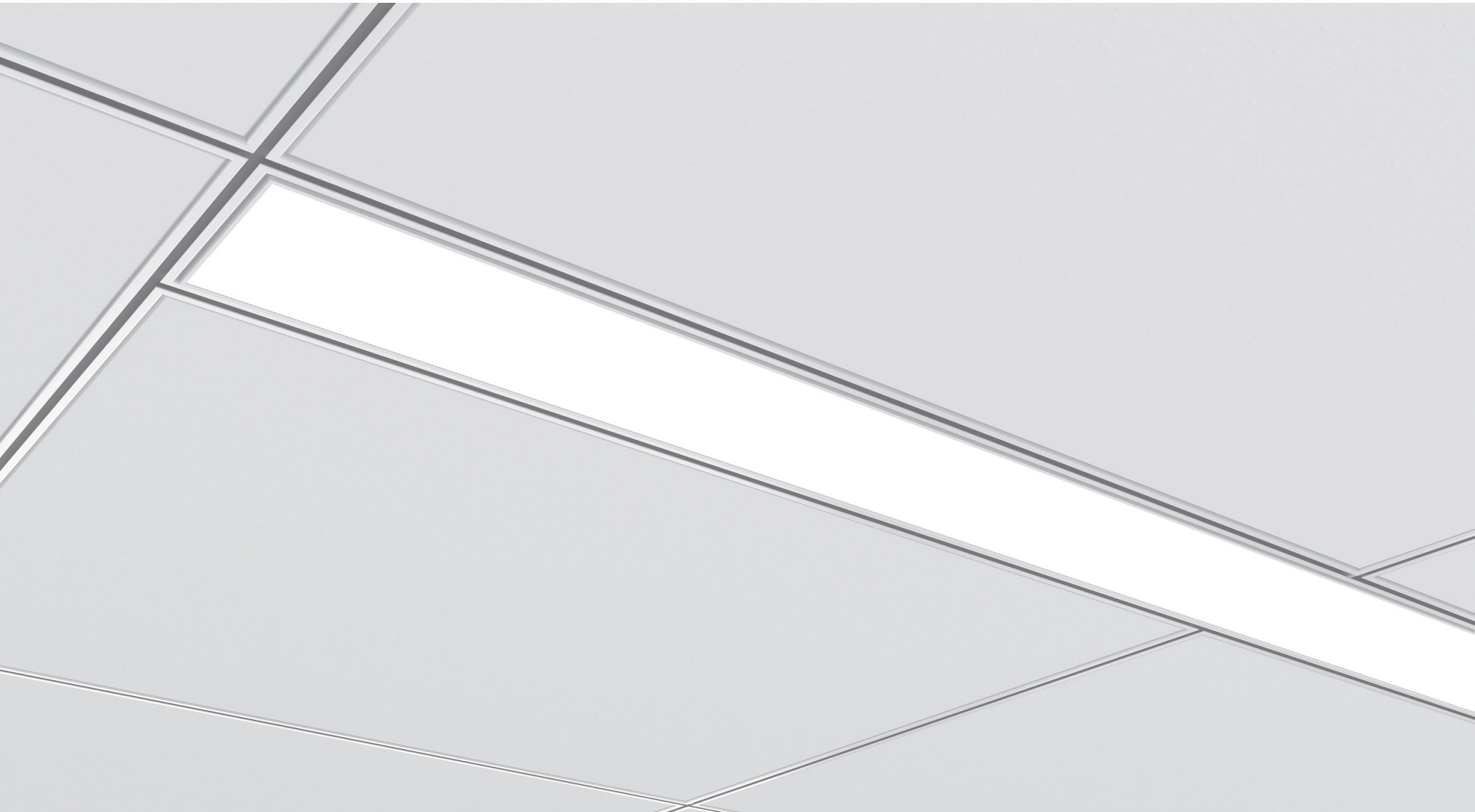

# Click clicks into place

Easy installation and maintenance

## 1 Tethering



Luminaire is securely hung to the T-bar to facilitate installation. No additional safety tethering required.

## 2 Wiring



Hinged, flip-down wiring compartment with full driver and wiring access.

## 3 Joining



Simple fixture-to-fixture mechanical, electrical and control connections. Features the patent-pending InstaJoiner.

## 4 Click in place

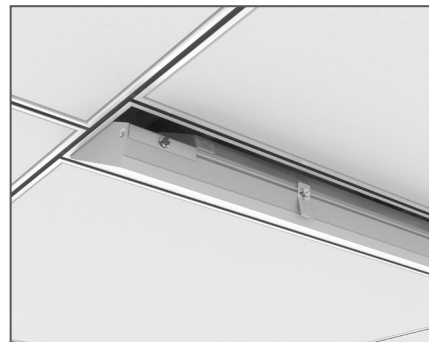

Full luminaire length clicks into place with patent-pending install-from-below system.



# Unique design features

## Easy maintenance



Click can be easily removed and maintained from below.

## Dual lens lightguide technology

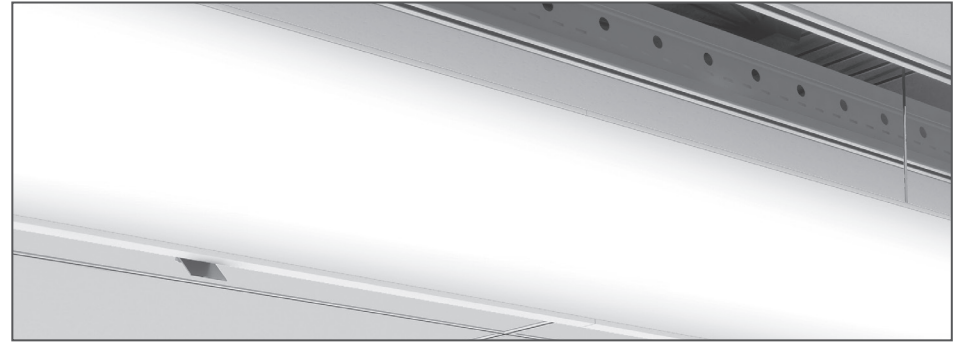

Axis patent-pending optics provides hairline joints and no view of LED diodes.

## InstaJoiner



Click features a unique patent-pending joining system developed by Axis. **InstaJoiner** provides fast, single-screw tightening, creating a solid, light-leak-free joint.

## Armstrong compatibility

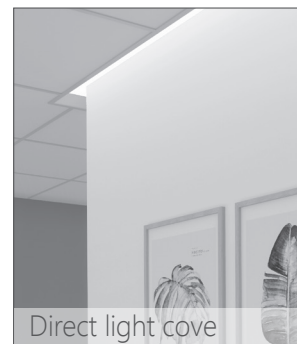

Direct light cove



Drywall grid system

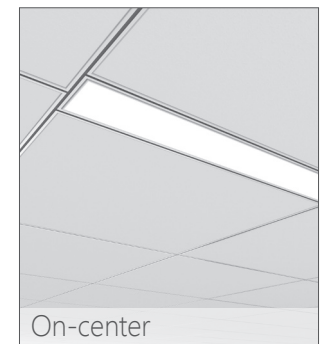

On-center

Also compatible with Armstrong acoustical on-center, direct light cove and drywall systems.

# Minimal height. Maximum performance.

Ultra-thin lightguide technology delivers low power density, uniform illumination and visual comfort.

Whether installed in continuous or non-continuous runs, Click delivers the right amount of light with a consistent finish and symmetric center-of-T design esthetic.

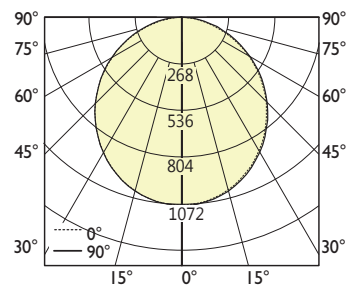
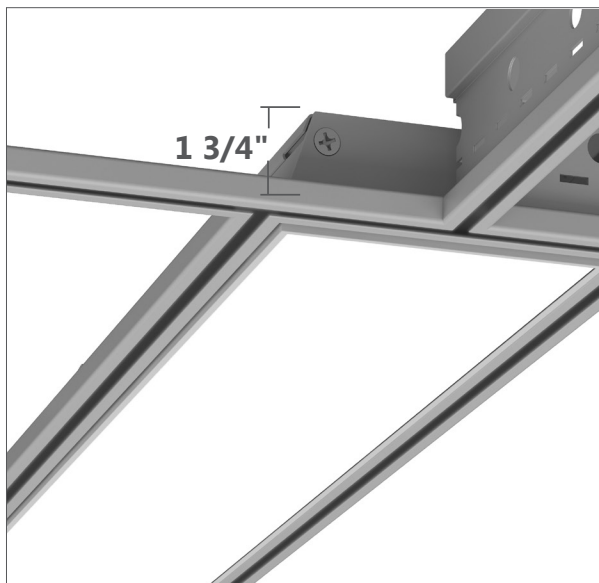

**Luminaire Lumens: 750 lm/ft**  
**Input Watts: 29.8 W**  
**Efficacy: 100 lm/W**

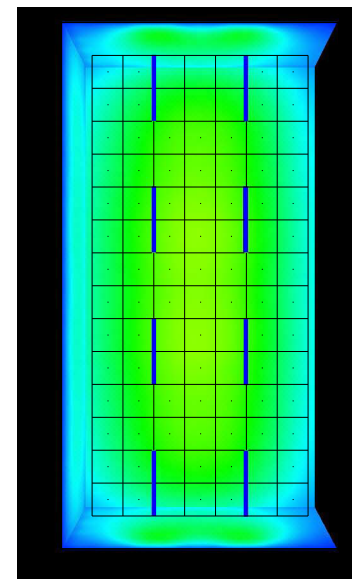
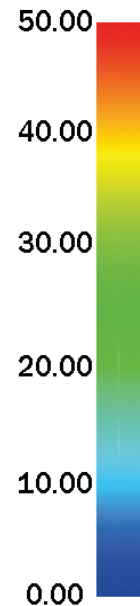

**Avg light levels: 31 fc**  
**Max/Min: 1.93**  
**Power Density: 0.34 W/ft<sup>2</sup>**  
**Room size: 32' x 18' x 8.5'**







# A winning combination

Click & **Armstrong**<sup>®</sup>

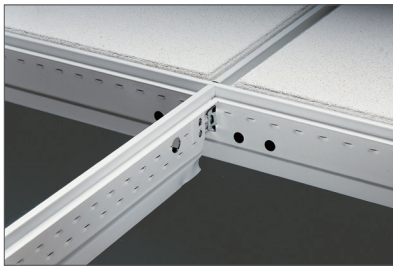

Interlude<sup>®</sup>

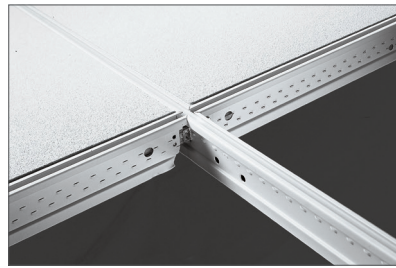

Silhouette<sup>®</sup>

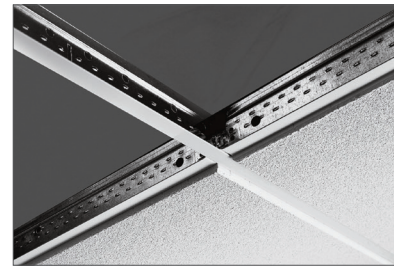

9/16" Suprafine<sup>®</sup>

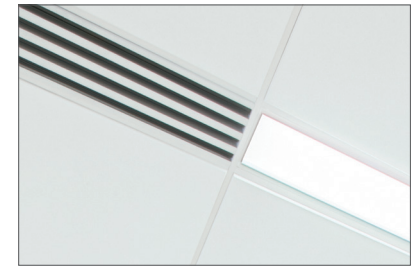

4" TechZone<sup>®</sup>



## Also compatible with:

Armstrong Drywall  
Linear Lighting Trim Kits



DGSLLTK

Armstrong  
Axiom Direct Light Covers

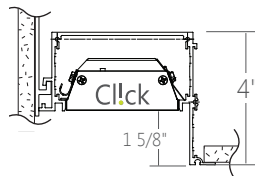

AXDLC44

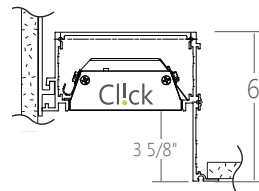

AXDLC46

## Armstrong Lighting Bracket Connector

Armstrong's Zero Plenum Lighting Connector Bracket (LCB4) enables center-of-T esthetic. With full access from below, luminaires can be installed after closing the ceiling.







eMeeting  
Product Renders

- Call
- Mail
- Share
- Print

## About Axis Lighting

Founded in 1991 and still family owned and managed, Axis is an important source for architectural lighting across North America and around the globe.

Over the last decade, the company has exhibited remarkable growth thanks to its commitment to Design Flexibility, Optimal Energy Efficiency and Responsive Customer Care. That leadership effort now extends to developing Innovative Lighting Technologies, such as SurroundLite™, on an ongoing basis.

On the strength of a broad and expanding product line, Axis has successfully completed lighting projects for high-profile clients including Apple, Chrysler, The Empire State Building, Google, Hyundai, Time Warner and McGill University, among many others.

Axis has the drive and the expertise to meet your needs and provide architectural lighting... your way.



Architectural Lighting. Your Way.

We reserve the right to change specifications without notice.  
Please consult our website for the most current technical information  
and to locate your nearest Axis representative.

1.800.263.AXIS  
[T] 514.948.6272  
[F] 514.948.6271

[axislighting.com](http://axislighting.com)

© 2017 Axis Lighting Inc.