



Integrated
LIGHTING
Solutions

Armstrong[®]
CEILING SOLUTIONS

Lighting INTEGRATION Made Easy

We understand the pain points of trying to integrate lighting into the ceiling plane while being able to specify and maintain the crisp, clean details you envision in the design.

Armstrong Ceiling Solutions has developed a complete assortment of integrated linear, cove, and downlight solutions that help create brilliant interior spaces with consistent fit and finish using your favorite Armstrong® ceiling panels and suspension systems.

LINEAR LIGHTING



4

WoodWorks®



5

MetalWorks™
Linear – Synchro™
& Diverge™



6

Formations™
Cloud Kits



7

Acoustical
On-Center



8

T-Bar Lighting



9

ACOUSTIBuilt®
& Drywall



10

On-the-Grid Linear &
Downlighting

LIGHT COVES

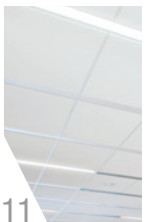

11

TechZone®
Ceiling Systems



12

DynaMax®
T-Bar Lighting



13

Axiom® Direct
Light Covers



14

Axiom® Indirect
Light Covers



15

Axiom® Indirect
Field Light Covers



16

Specialty Ceilings
Axiom® Indirect
Field Light Covers



17

Axiom® Indirect
Light Ledge



18

Curved Axiom®
Indirect
Light Covers



DOWNLIGHTING



19

Intersection



20

Center Cut Panel



21

Specialty Ceilings
WoodWorks®



22

Specialty Ceilings
MetalWorks™

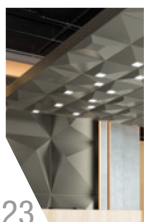

23

Specialty Ceilings
CastWorks™



24

DynaMax®
Panel
Downlighting



26

Integrated
Solutions Matrix

PARTNERS



Specialty Ceilings

WOODWORKS®

Linear Lighting

- ▶ Install lights seamlessly for WoodWorks® Grille, Grille Tegar, Linear Solid Wood panels, and Linear Veneered panels
- ▶ Low-profile, pre-engineered light fixture in 2", 3-1/4", and 5-1/4" widths from Backlight® srl and XAL® for a flush, sleek visual
- ▶ Engineered and tested Integrated Light Connection Clip and suspension system perfectly integrate lighting with grid. No need to independently suspend light fixtures or modify suspension system
- ▶ Approved for use in all seismic categories

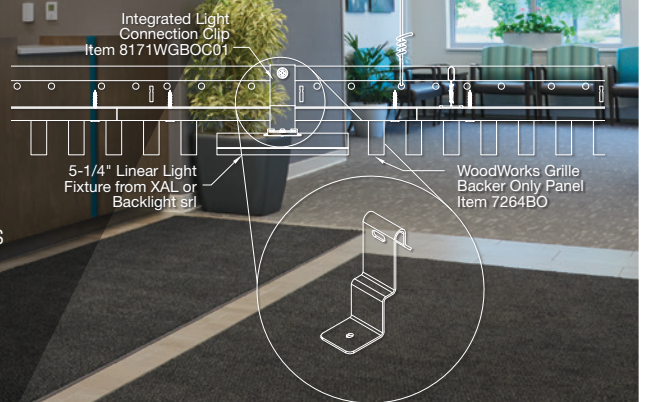



← Lobby & S

Specialty Ceilings METALWORKS™ Linear Lighting

- ▶ Install field-cut lighting options seamlessly for MetalWorks™ Linear – Synchro™ and MetalWorks™ Linear – Diverge™ planks
- ▶ Field-cut linear lighting options from Axis®, Backlight, and XAL® tested for fit and finish provide a flush, sleek visual
- ▶ Two fixture installation methods offer design flexibility while maintaining a flush fit. Planks can be replaced with a light or field-cut to house fixture within plank
- ▶ Approved for use in all seismic categories

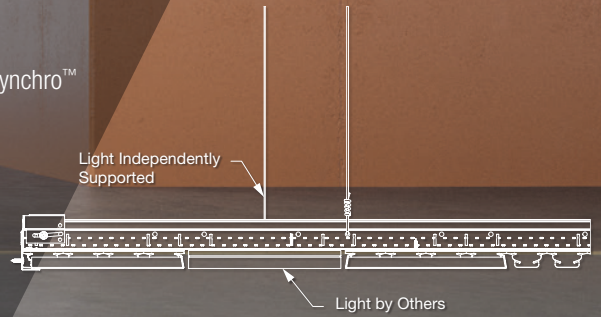



FORMATIONS™

Lighting Cloud Kits

- ▶ Variety of options – configurations, panels, sizes, trim color, lighting, and applications – the possibilities are endless
- ▶ Wide range of standard Axiom® trim and suspension system colors adds a custom look in easy-to-order specify kits
- ▶ Kits come complete with our StrongBack™ carrying channel, eliminating 40% of the cables – minimizing visible wires

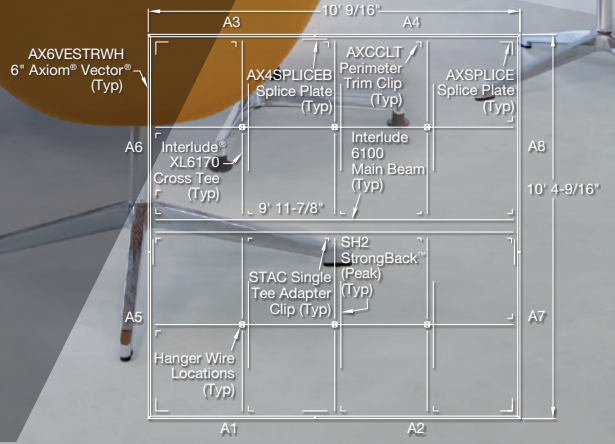



Acoustical ON-CENTER Linear Lighting

- ▶ Continuous or non-continuous layouts – inspiring symmetry to match your building design
- ▶ Zero interference – eliminates interference with mechanicals in the plenum
- ▶ Visually replaces main runner; aligns lighting with grid module
- ▶ FastSize™ Panels and Suspension Systems Program – sizes you need, factory-finished



T-BAR Lighting

- ▶ Zero plenum fixture for increased ceiling heights and seamless integration
- ▶ Sleek energy-efficient fixtures can reduce energy consumption
- ▶ Maintain a uniform lighting design in your space with the option of multiple optics from a single fixture
- ▶ The JLC-Tech T-Bar LED™ replaces a cross tee member in a suspended ceiling system (15/16" & 9/16" Suspension System) and integrates with WoodWorks® Grille Tegular; CastWorks™ Metaphors® Ceiling Panels; Ultima®; Calla®; Optima® and Lyra® Vector®. T-Bar Flex™ integrates with DesignFlex®
- ▶ The Vode ZipTwo™ micro mounts to the face of a T-Bar member with a low-profile clip

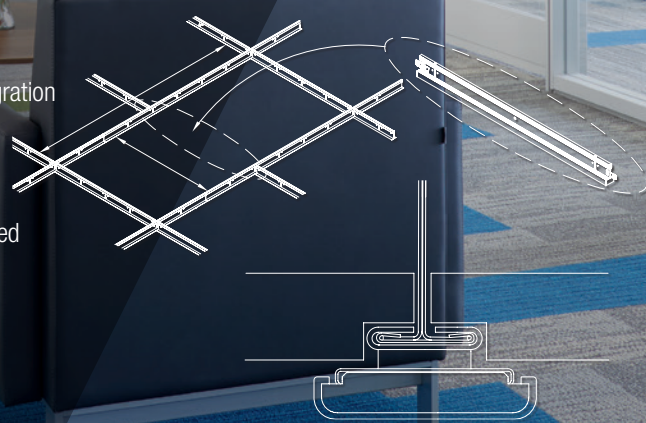

ACOUSTIBUILT® & DRYWALL Linear Lighting

- ▶ Pair ACOUSTIBuilt® Seamless Acoustical Ceiling Panels or drywall ceilings with integrated linear lighting in either continuous or non-continuous layouts for a clean, modern aesthetic
- ▶ Complete the monolithic look with LED fixtures in long runs – varying length and spacing true to design intent
- ▶ Light fixture installs from below, allowing optimal ceiling height

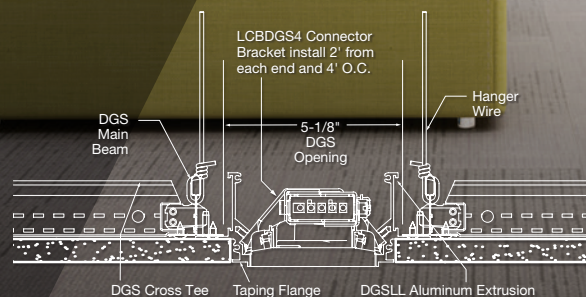



ON-THE-GRID

Linear & Downlighting

- ▶ Zero plenum interference with unique on-the-grid installation, locate on any Cross-T or main runner
- ▶ FastSize™ panels and suspension systems program available for field labor savings by eliminating field cutting of adjacent tiles and grid
- ▶ Energy-efficient fixture with light guide optical system ensures comfortable, low-glare illumination while saving watts per square foot

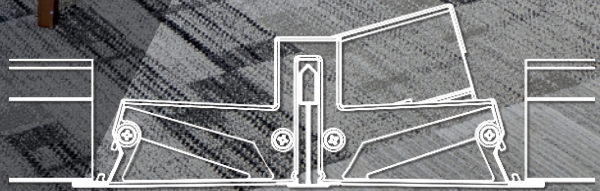



TECHZONE®

Ceiling Systems

- ▶ Create a sleek ceiling design with uninterrupted ribbons of light
- ▶ Alternate continuous lights and diffusers with other technical services for a monolithic, uncluttered visual
- ▶ Ability to use with 4" and 6" configurations

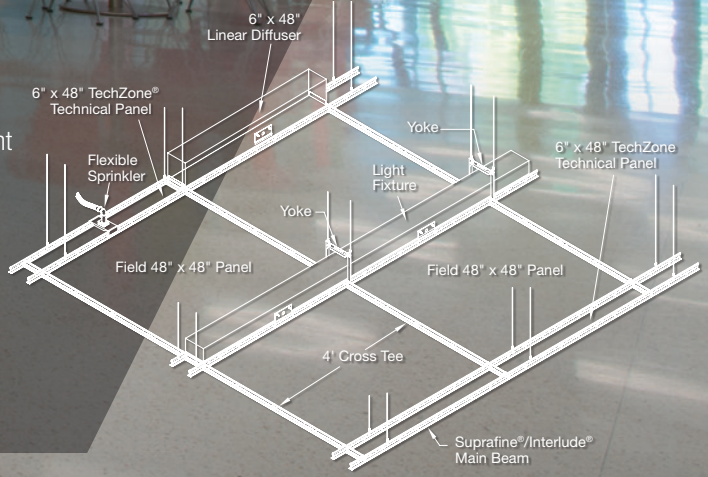



T-Bar Lighting for DYNAMAX® & DYNAMAX PLUS Suspension Systems

- ▶ Pre-engineered fixtures and components that integrate, work with, or complement DynaMax® and DynaMax Plus structural suspension system
- ▶ Easy to specify light fixture options from VODE® ZipTwo™ and JLC-Tech TERALyte™ connect seamlessly to the DynaMax and DynaMax Plus grid system
- ▶ Integrated ceiling solutions with compatible components designed for data centers for a certified fit and finish
- ▶ Eliminates the need to field modify

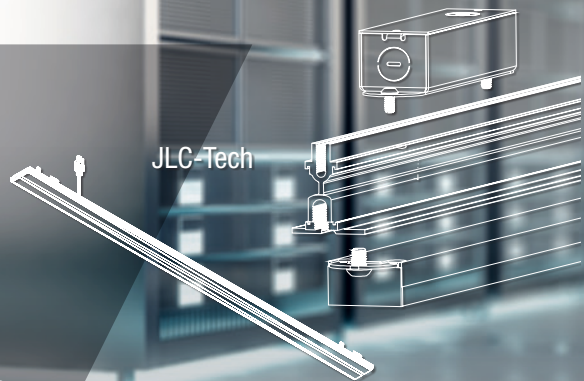

JLC-Tech

Vode®

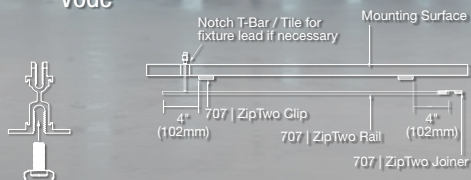

AXIOM[®]

Direct Light Covers

- ▶ Pre-engineered for predictable lighting performance and perfect integration
- ▶ Fully concealed design installs with all Armstrong[®] acoustical, drywall, specialty ceilings, and ACOUSTIBuilt[®] suspension systems
- ▶ Low profile design with plug-and-play lighting for shallow plenum corridors and entryways

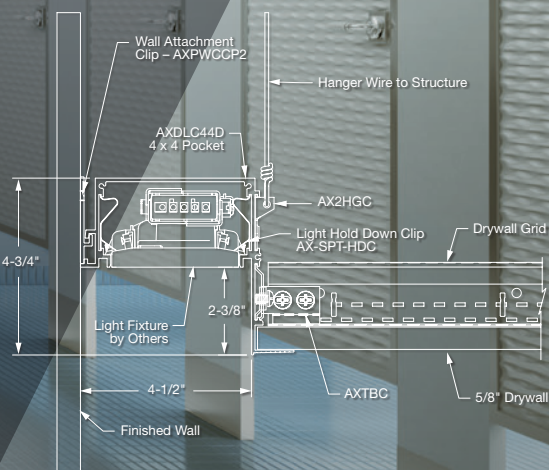



AXIOM®

Indirect Light Covers

- ▶ Variety of options from both ceiling-to-wall and ceiling-to-ceiling light covers in a wide range of sizes
- ▶ Acoustical and drywall designs with Axiom® Classic or Axiom® Knife Edge® profiles
- ▶ New Knife Edge profile brings the acoustical panel out to the edge of the cover

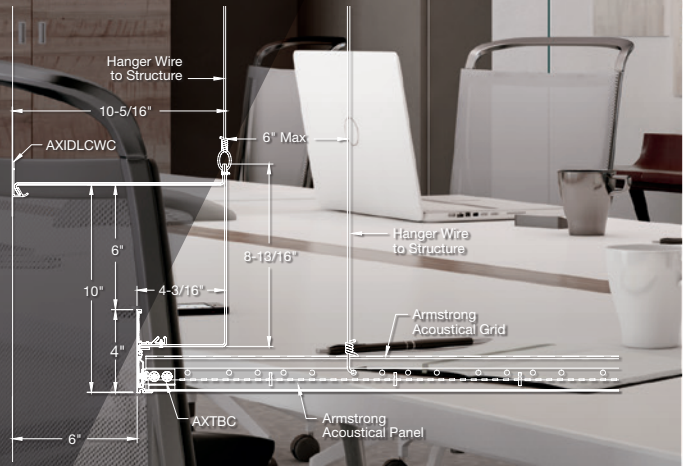



AXIOM[®] Indirect Field Light Covers

- ▶ Adjustability of the drywall vertical leg allows for field modification and ability to cut to the length desired
- ▶ Designed with a notched channel for perfect integration with Axis[®] Lighting and Vode[®] Lighting fixtures
- ▶ Pre-manufactured corners
- ▶ Easy to specify – control over finished aesthetics

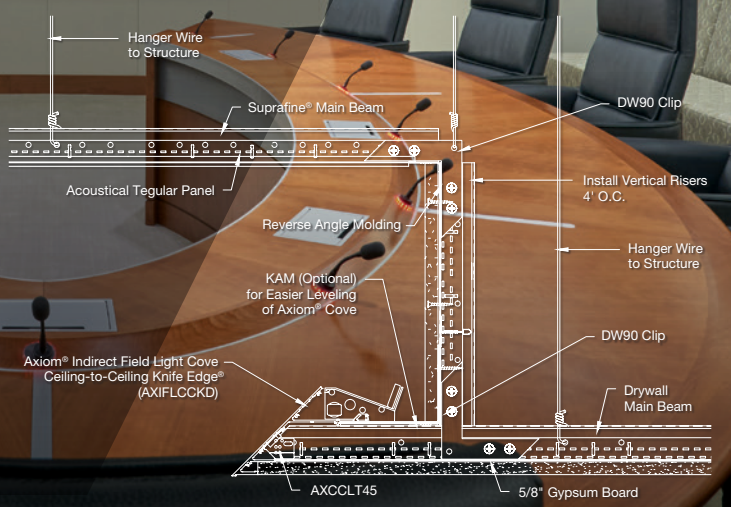



Specialty Ceilings

AXIOM[®]

Indirect Field Light Covers

- ▶ Offers predictable lighting performance and perfect integration with select Armstrong[®] WoodWorks[®] and Metalworks[™] ceilings and suspension systems
- ▶ Offers a variety of options with both Ceiling-to-Wall and Ceiling-to-Ceiling light coves and sizes
- ▶ Classic and Knife Edge[®] profiles
- ▶ Easy to specify – pre-engineered light cove and light fixtures

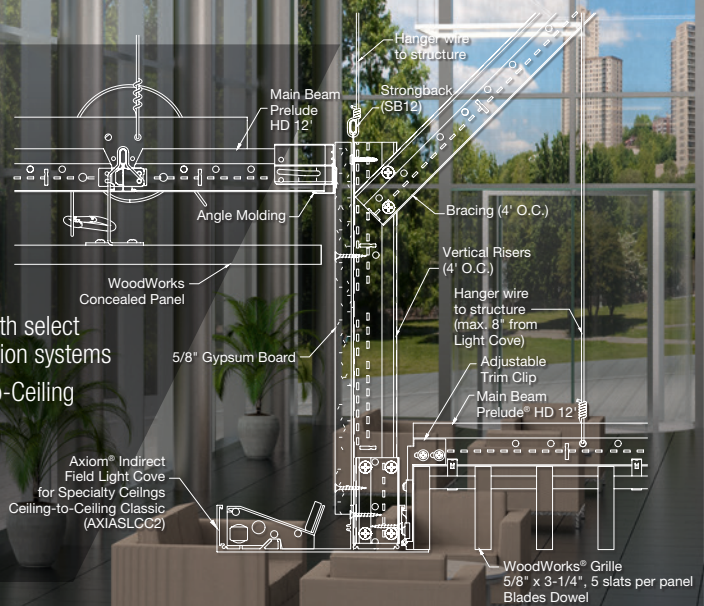



AXIOM[®] Indirect Light Ledge

- ▶ Pre-engineered for predictable lighting performance and perfect integration
- ▶ Axiom[®] Indirect Light Ledge is part of the Sustain[®] portfolio and meets the most stringent industry sustainability compliance standards today
- ▶ Variety of options for both Ceiling-to-Wall and Ceiling-to-Ceiling light ledges

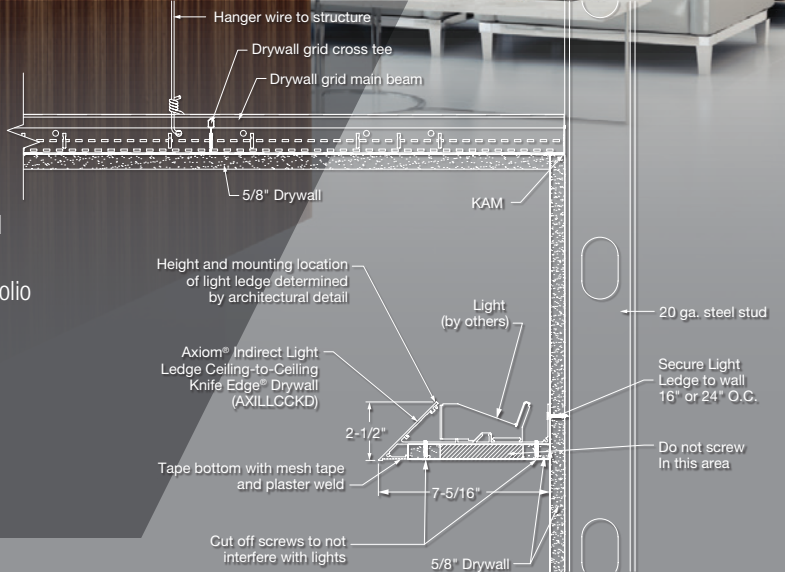



CURVED

Axiom® Indirect Light Covers

- ▶ Available in Axiom® Indirect Field Light Cove and Axiom® Indirect Light Ledge
- ▶ Light Covers can now follow the curve of the design
- ▶ Axiom® Indirect Light Covers are part of the Sustain® portfolio and meet the most stringent industry sustainability compliance standards today
- ▶ 60" minimum inside and outside radii

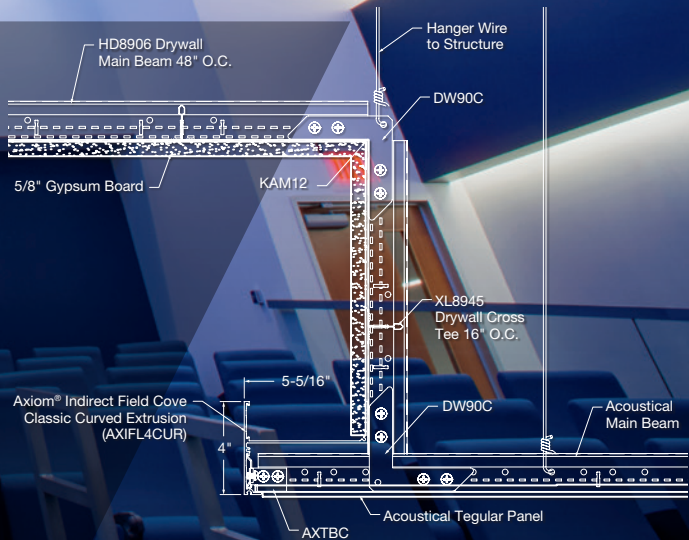

INTERSECTION

Downlighting

- ▶ Seamlessly integrate recessed downlights at the intersection of the grid
- ▶ Deliver the vision of symmetry and consistency in the design
- ▶ Replace inconsistent finishes and edge details with clean, crisp factory-finished Calla®, Lyra®, Ultima®, and Optima® notched panels

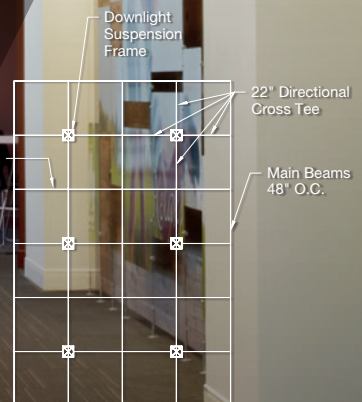

CENTER CUT

Panel Downlighting

- ▶ Aesthetic of a drywall trimless downlight in acoustical panel
- ▶ Monolithic look with crisp, integrated lighting
- ▶ Pre-cut downlight opening available for 3.5" or 5" square or round lights
- ▶ No on-site cuts needed

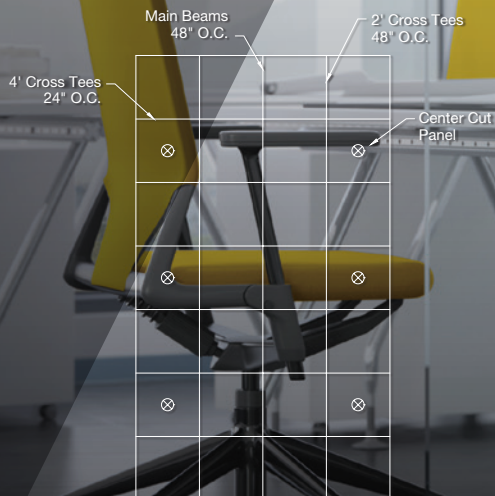



Specialty Ceilings
WOODWORKS®
Downlighting

- ▶ Create a sleek visual using pre-engineered downlight solutions from USAI® with WoodWorks® Grille, Grille Tegular, and Linear Solid Wood panels
- ▶ Flush-fit light fixtures in many styles and sizes illuminate a space, while virtually disappearing in the ceiling
- ▶ No need to independently suspend light fixtures or modify suspension system
- ▶ Easy to field modify panels to incorporate new downlight fixtures
- ▶ Partner lighting connection to suspension system is fully adjustable

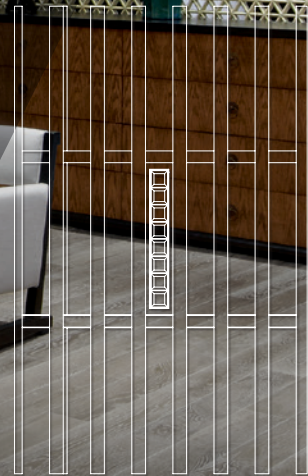



Specialty Ceilings

METALWORKS™

Downlighting

- ▶ Precise factory-cut MetalWorks™ Torsion Spring, Torsion Spring Shapes, and Clip-on ceiling panels seamlessly integrate with USAI® trimless, square downlights
- ▶ Perfectly centered fixtures, perfectly cut tiles – every time
- ▶ Time and labor savings solution – downlight fixtures are fully adjustable within the system so there is no cutting, no mess, and no need to remove panels
- ▶ Select pre-cut panels for downlight fixtures available in FAST134 program
- ▶ Pre-engineered and tested for fit and finish in all seismic areas

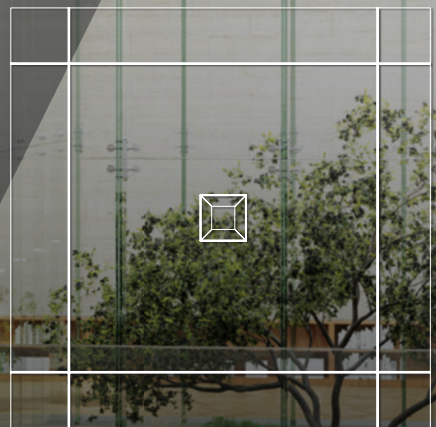



Specialty Ceilings
CASTWORKS™
Downlighting

- ▶ Integrate downlighting solutions seamlessly from USAI® into CastWorks™ Metaphors® Ceiling Panels
- ▶ Perfectly fit fixtures – every time
- ▶ Select panels with downlight openings available in FAST134 program





Recessed LED Fixtures for DYNAMAX[®] & DYNAMAX PLUS Downlighting

- ▶ Pre-engineered fixtures and components that integrate, work with, or complement DynaMax[®] and DynaMax Plus structural suspension system
- ▶ Axis TRAYFIT™ and H.E. Williams PTDC shallow plenum troffer in 2' x 2' and 2' x 4' nominal sizes available, specially-sized to fit into the oversized structural grid
- ▶ Light fixture options from Axis[®] integrate seamlessly with the grid system
- ▶ Easy-to-specify integrated ceiling solutions with compatible components designed for data centers for a certified fit and finish
- ▶ Eliminates the need to field modify

Axis TRAYFIT™

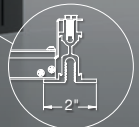
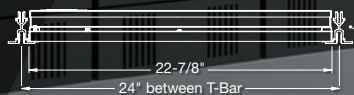
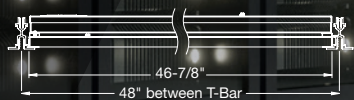

H.E. Williams PTDC

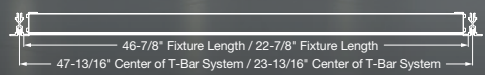

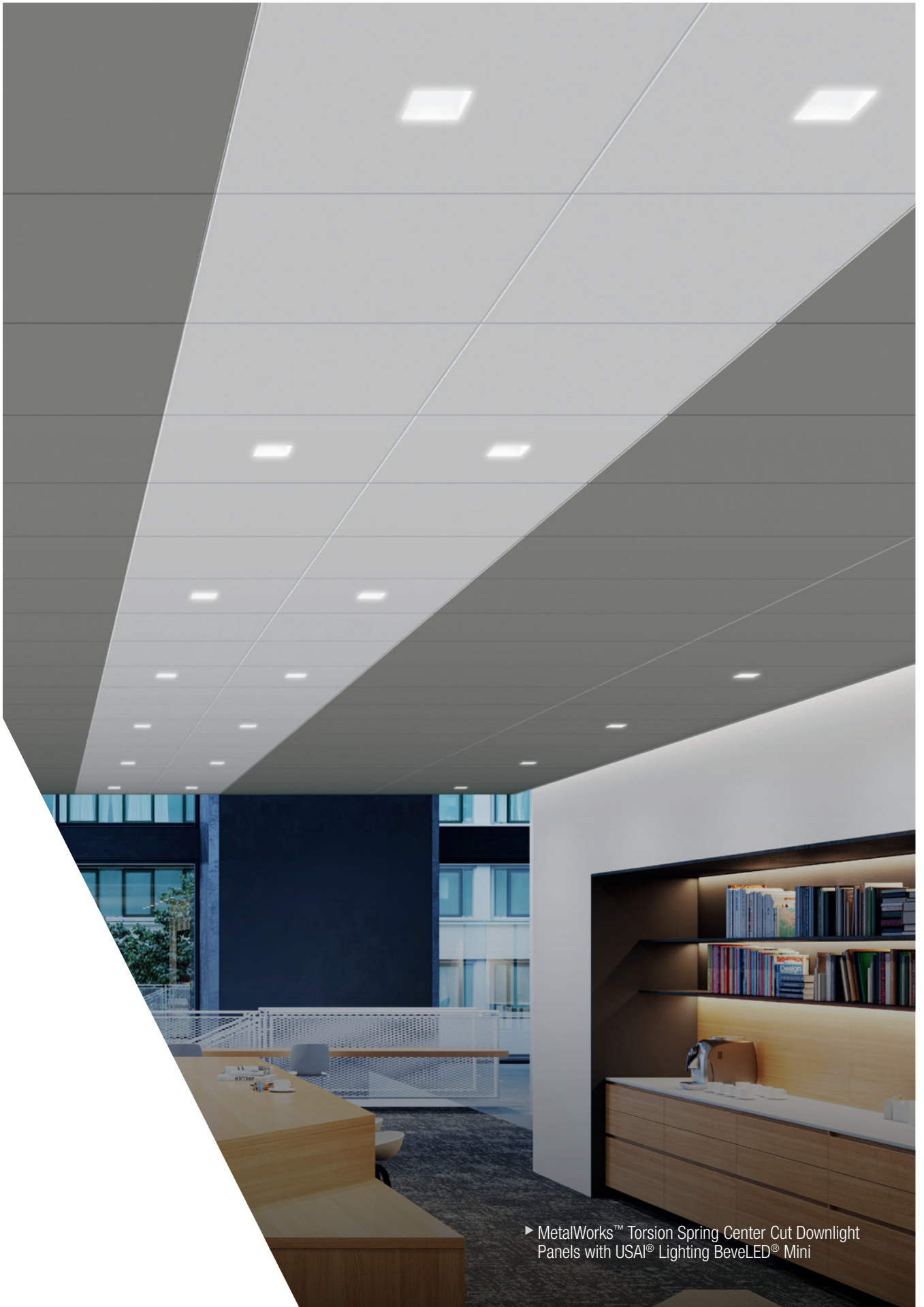

► MetalWorks™ Torsion Spring Center Cut Downlight Panels with USAI® Lighting BeveLED® Mini

Lighting PARTNERS

Integrated Solutions Matrix

PARTNERS	LINEAR LIGHTING											LIGHT COVES				DOWNLIGHTING							
	MetalWorks™ Linear – Diverge™	MetalWorks™ Linear – Synchro™	WoodWorks®	Formations™	Acoustical On-Center	T-Bar Lighting	ACOUSTIBuilt® & Drywall	On-Grid Linear/Downlighting	DesignFlex®	TechZone®	Data Center	CastWorks™	Axiom® Direct Light Coves	Axiom® Indirect Light Coves	Axiom® Indirect Light Ledge	Axiom® Indirect Field Light Coves for Specialty Ceilings	Intersection	Center Cut Panel	WoodWorks®	MetalWorks™	TechZone®	CastWorks™	
ARON™							•																
axis	•			•	•		•	•	•	•		•	•	•	•								
BACKLIGHT	•	•	•																				
Williams										•													
JLC • tech			•			•		•		•	•												
USAI® Lighting				•		•										•	•	•	•	•	•	•	•
vode						•				•			•	•	•								
XAL	•	•	•	•	•		•		•			•											

All names listed on this page are trademarks, registered trademarks, or service marks of their respective owners.

* Backlight and XAL® are compatible with Woodworks® Grille, Woodworks® Grille Tegular, Woodworks® Linear Solid Wood Panels, and Woodworks® Linear Veneered Panels

** JLC Tech is compatible with WoodWorks Grille Tegular

*** USAI® is compatible with Woodworks Grille, Woodworks Grille Tegular, Woodworks Linear Solid Wood Panels, MetalWorks™ Clip-On, MetalWorks™ Torsion Spring, and MetalWorks™ Torsion Spring Shapes

TAKE THE NEXT STEP

1 877 276 7876

Customer Service Representatives
7:45 a.m. to 5:00 p.m. EST
Monday through Friday

TechLine – Technical information, detail drawings,
CAD design assistance, installation information,
other technical services – 8:00 a.m. to 5:30 p.m. EST,
Monday through Friday. FAX 1 800 572 8324
or email: techline@armstrongceilings.com

armstrongceilings.com/lighting

Latest product news

Standard and custom product information

Online catalog

CAD, Revit®, SketchUp® files

A Ceiling for Every Space® Visual Selection Tool

Product literature and samples – express service
or regular delivery

Contacts – reps, where to buy, who will install

ARON is a trademark of Aron Lighting
Backlight is a trademark of BACKLIGHT srl
Axis, LENO® Luminaire, Axis Click, CovePerfekt™, and TRAYFIT™ are trademarks of Axis Lighting Inc.
Price® is a trademark of Price Industries
Revit® is a trademark of Autodesk, Inc.
SketchUp® is a trademark of Trimble, Inc.
H.E. Williams logo is a registered trademark of H.E. Williams, Inc.
JLC-Tech, T-Bar LED™, and TERALyte™ are trademarks of JLC-Tech, LLC
USAI® and BeveLED® are registered trademarks of USAI, LLC
Vode® and ZipTwo™ are trademarks of Vode® Lighting LLC
XAL® is a trademark of XAL Inc.
All other trademarks used herein are the property of AWI Licensing LLC and/or its affiliates
© 2023 AWI Licensing LLC • Printed in the United States of America

armstrongceilings.com/lighting

 **Armstrong**®
CEILING SOLUTIONS