



INTERSECTION  
Downlighting  
Integrated  
Lighting Solutions



# Lighting INTEGRATION Made Easy

Armstrong® Ceiling Solutions and USAI® Lighting partnered to offer architects and designers a new way to seamlessly integrate recessed downlights with architectural suspension systems. Now for the first time, LED light fixtures can be placed at the intersections of the ceiling grid — allowing for perfect alignment of lighting and architecture.

- ▶ Grid, ceiling panels, and light meet seamlessly at the intersection with pre-cut factory finished panels and grid
- ▶ Compatible with the USAI® Lighting Connect™ Family
- ▶ Snap-in-place one piece universal housing for light

## PROBLEM

Downlight placement must penetrate ceiling panels creating a typical and dated look.

## SOLUTION

Eliminate the worry of field-modified panels and grid. Factory-finished panels to go with the Intersection Downlighting Kit make this previously impossible condition flawless and consistent.

# perfect alignment







# INTERSECTION DOWNLIGHTING

With our new 4" Intersection Downlighting Kit and in collaboration with USAI® Lighting, lights can now be placed at grid intersections.

- ▶ Eliminate the worry of field modified panels and grid
- ▶ Place light where it has never been before
- ▶ Compatible with the USAI® Lighting Connect™ Family
- ▶ Suitable for seismic installations in D, E, F areas

## KIT CONTENTS:

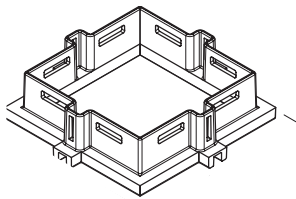

(1) Downlight Suspension Frame

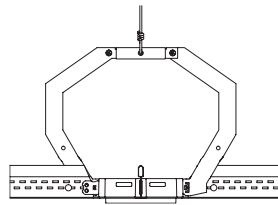

(1) High-Profile Yoke  
(not assembled – comes in two pieces)\*

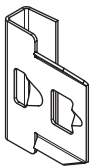

(2) Cross Tee Connection Clips

\* Alternate low profile yoke for low plenum applications available - Item #: FZD4YKLP

## Calla® for Intersection Downlighting (8 panels per carton)

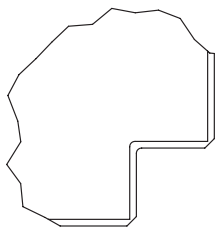

Calla® Notched Directional Ceiling Panel – Item #: 2818\*\*

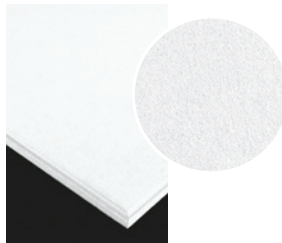

Calla Square Tegular

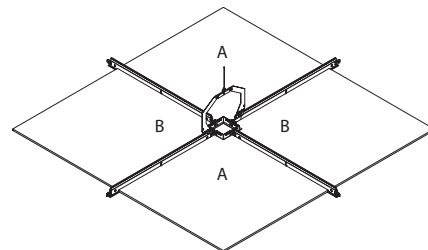

Intersection Downlighting Assembly with Calla Notched Ceiling Panels

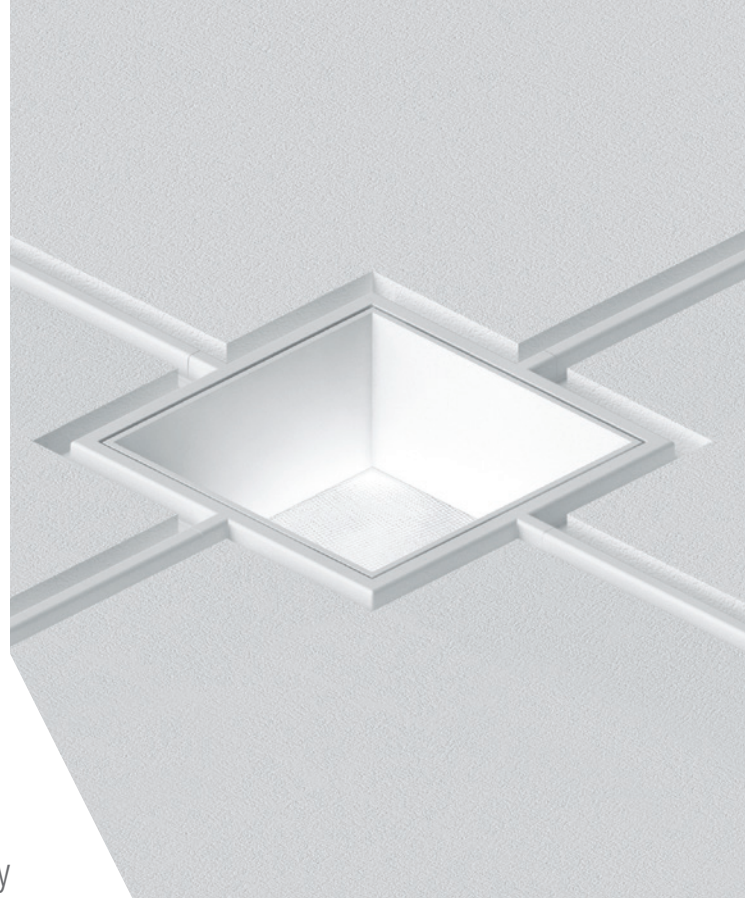

Compatible with the below 9/16" Armstrong® suspension systems

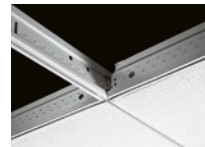

Silhouette® 1/4" reveal

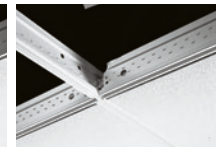

Silhouette® 1/8" reveal

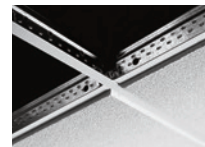

Suprafine® XL®



Interlude® XL® HRC

\*\*Panels sold separately from grid components

# CONNECT™ FAMILY

**USAI®**  
Lighting

CONNECT™ – The newest member of USAI® Lighting’s award winning family offers designers exact fixture spacing on a pre-determined grid to seamlessly integrate lighting with building design, achieving perfect alignment and consistency.

## CONNECT™ FEATURES:



### COLOR HARMONY®

Consistent and reliable classic white light from fixture-to-fixture within a 2-Step MacAdam Ellipse.



### WARM GLOW® DIMMING

Provides the warmth and glow once possible only in dimmed incandescent sources. Patented technology mimics the dimming curve of a standard incandescent lamp.



### COLOR SELECT®

Patented Tunable White color control from cool to warm. Allows independent adjustment of color and intensity from daylight to candlelight.

## CONNECT™ Trim Dimensions

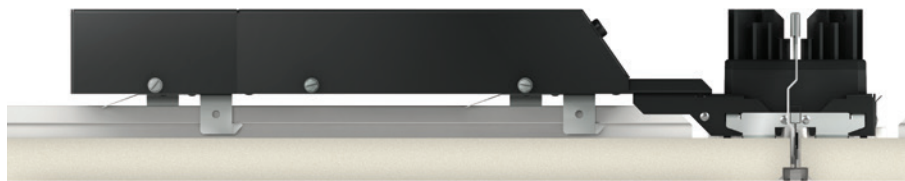
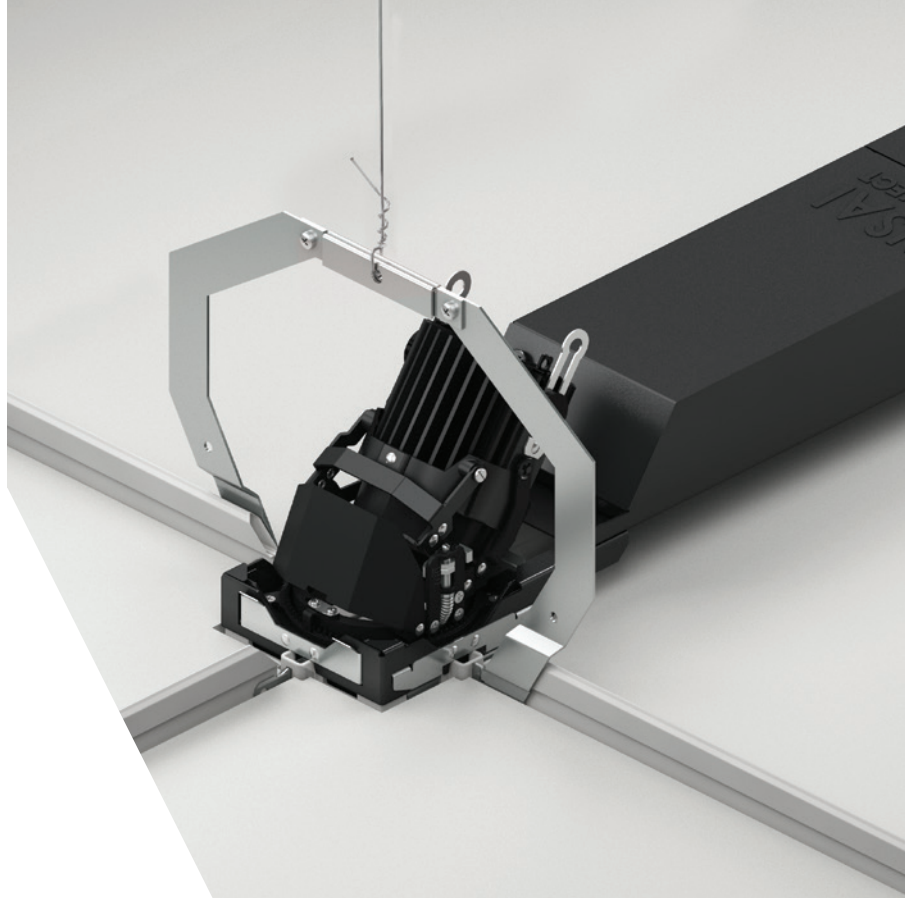
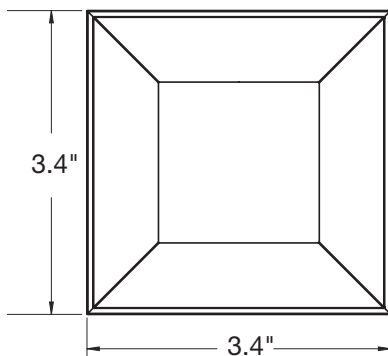

## CONNECT™ Trim Options

### BeveLED® CONNECT™ for 4" Intersection

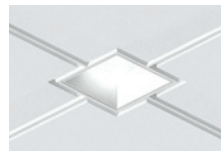

Downlight – C4SBD

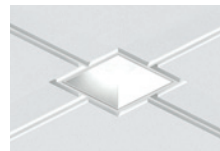

Adjustable – C4SBA

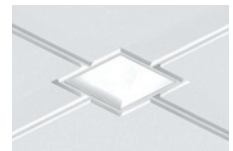

Wall Wash – C4SBW

### SliverLED® CONNECT™ for 4" Intersection

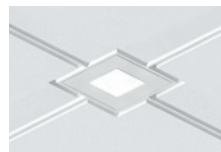

Downlight – C4SSD

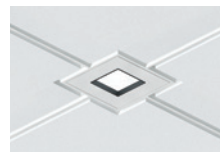

Adjustable – C4SSA

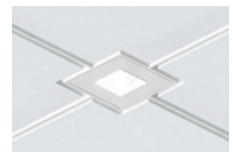

Wall Wash – C4SSW

### True Zero® CONNECT™ for 4" Intersection

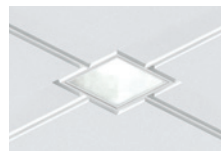

Downlight – C4SZD

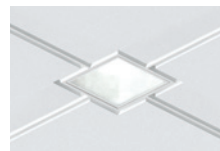

Adjustable – C4SZA

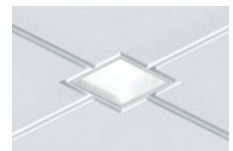

Wall Wash – C4SZW

# HOW TO SPECIFY INTERSECTION DOWNLIGHTING

## 1

### Design your layout

Select from one of our standard layouts or create your own configuration

2' x 2' Ceiling layout with lights 4' apart

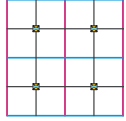

2' x 2' Ceiling layout with lights 6' apart

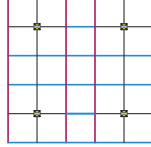

2' x 2' Ceiling layout with lights 8' apart

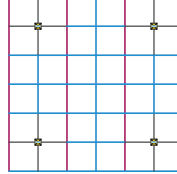

30" x 30" Ceiling layout with lights 5' apart

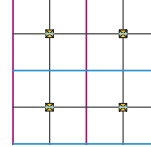

30" x 30" Ceiling layout with lights 7.5' apart

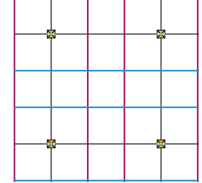

## 2

### Choose your 9/16" Profile Intersection Downlighting Kit (8 kits per carton)

(main beams, standard cross tees, wall molding, and lights need to be ordered separately)

#### Compatible Armstrong® suspension systems

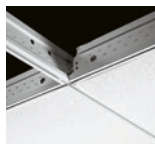

Silhouette® 1/4" reveal

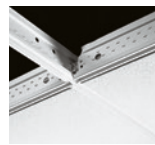

Silhouette® 1/8" reveal

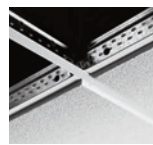

Suprafine® XL®



Interlude® XL® HRC

Item No.	Description
<b>Silhouette® XL® 1/4" Reveal</b>	
<input type="checkbox"/> 76D4SK _ _	4" Downlight Hub Kit w/ Yokes & hardware
<input type="checkbox"/> XL7622DL _ _	24" Module Downlight Cross Tee
<input type="checkbox"/> XL7628DL _ _	30" Module Downlight Cross Tee
<input type="checkbox"/> XL7646DL _ _	48" Module Downlight Cross Tee

Item No.	Description
<b>Silhouette® XL 1/8" Reveal</b>	
<input type="checkbox"/> 768D4SK _ _	4" Downlight Hub Kit w/ Yokes & hardware
<input type="checkbox"/> XL76822DL _ _	24" Module Downlight Cross Tee
<input type="checkbox"/> XL76828DL _ _	30" Module Downlight Cross Tee
<input type="checkbox"/> XL76846DL _ _	48" Module Downlight Cross Tee

Item No.	Description
<b>Suprafine® XL®</b>	
<input type="checkbox"/> 75D4SK _ _	4" Downlight Hub Kit w/ Yokes & hardware
<input type="checkbox"/> XL7522DL _ _	24" Module Downlight Cross Tee
<input type="checkbox"/> XL7528DL _ _	30" Module Downlight Cross Tee
<input type="checkbox"/> XL7546DL _ _	48" Module Downlight Cross Tee

Item No.	Description
<b>Interlude® XL® HRC</b>	
<input type="checkbox"/> 61D4SK _ _	4" Downlight Hub Kit w/ Yokes & hardware
<input type="checkbox"/> XL6122DL _ _	24" Module Downlight Cross Tee
<input type="checkbox"/> XL6128DL _ _	30" Module Downlight Cross Tee
<input type="checkbox"/> XL6146DL _ _	48" Module Downlight Cross Tee

Item No.	Description
<b>Accessories</b>	
<input type="checkbox"/> FZD4YKLP	Low-Profile Yoke
<input type="checkbox"/> SH1206	PeakForm Support Hanger with Routing 6" O.C.

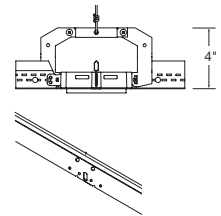

#### COLORS



#### Kit Components Included: (8 Kits per carton)

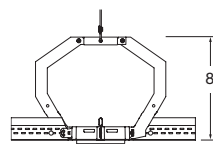

(1) High-Profile Yoke (not assembled – comes in two pieces)\*

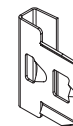

(2) Cross Tee Connection Clips

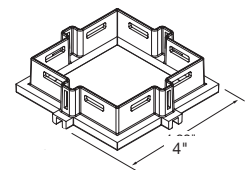

(1) Downlight Suspension Frame

†† Add the 2-letter color suffix to the item number when specifying or ordering (Example: AX2WEC\_Z\_W)

\* Alternate low profile yoke for low plenum applications available - Item #: FZD4YKLP  
 NOTE: Low-profile yoke is compatible with USAI® Lighting CONNECT™ Family Downlight and Wall Wash lighting options. High-profile yoke is compatible with USAI Lighting CONNECT Family Downlight, Adjustable, and Wall Wash lighting options.

# 3

## Choose your ceiling panel (8 pieces per carton)\*

### VISUAL SELECTION

### PERFORMANCE SELECTION Dots represent high level of performance.

Edge Profile	Item No.	Dimensions (Inches)	NRC	+	CAC	=	Total Acoustics <sup>1</sup>	Articulation Class	Fire Rating	Light Reflect	Anti-Mold & Mildew	Sag Resist	Certified Low VOC Emissions	Wash	Impact	Scratch	Soil	Recycled Content	Recycle Program	30-Yr Warranty
<b>CALLA® Notched Ceiling Panels**</b>																				
9/16" Square Tegular	<b>2818</b>	24 x 24 x 1"	0.85		35		<b>BEST</b>	170	Class A	0.86	•	•	•	•	•	•	•	•	•	•
<b>CALLA® Compatible Full Size Panels</b>																				
9/16" Square Tegular	<b>2824</b>	24 x 24 x 1"	0.85		35		<b>BEST</b>	170	Class A	0.86	•	•	•	•	•	•	•	•	•	•

\*\* These pieces are directional panels and come as (8) marked pieces per carton (4A's / 4B's)

# 4

## Choose your Connect™ family, fixture, and color technology

USAI® Connect™ products are available in full downlight, adjustable and wall wash families with three trim styles options. See specification example below. Please visit [usaighting.com/connect](http://usaighting.com/connect) for full details.

### BeveLED® Connect™ Downlight – Sample Specification

FAMILY		COLOR TECHNOLOGY			FIXTURE					
C4SBD	CT	Wattage Options	LED Color Temperature Options	Beam Options	Lens Options	Trim Finish Options	Voltage Options	Dimmer Driver Options	Accessories (Optional)	
C4SBD Connect 4" Square BeveLED Downlight	CT Connect Intersection Housing	<b>Classic White</b>			25 25° beam 35 35° beam 50 50° beam	S Solite (provided standard)  F Frosted	GW Global White (provided standard)  ZW Blizzard White (optional)	UNV 120V-277V	For use with Universal Voltage 120V - 277V  D2 0-10V dim, 10% (provided standard)  D4 Lutron Hi-Lume 1% 3-wire/ECO  D6A EldoLED 0-10V, 0.1%, logarithmic/Lutron controls  D6B EldoLED 0-10V, 0.1%, linear controls  D6E EldoLED 0-10V, 1%, logarithmic/Lutron controls  D6F EldoLED 0-10V, 1%, linear controls  D7 EldoLED DALI, 0.1%  D8 EldoLED DMX, 0.1% 1,2	EM Emergency Battery
		<b>Warm Glow Dimming</b>								
		12 WG1 12W LED 18WG1 18W LED	2722KS - 2700K-2200K, 80+ CRI 3022KS - 3000K-2200K, 80+ CRI 3522KS - 3500K-2200K, 80+ CRI 2722KH - 2700K-2200K, 90+ CRI 3022KH - 3000K-2200K, 90+ CRI							
		<b>Color Select</b>								
		12CS1 12W LED 18CS1 18W LED	6022KS 6000K-2200K Tunable White Light 80+ CRI	30 30° beam 40 40° beam 50 50° beam			120V	For use with 120V only  D3 Lutron Hi-Lume 1% 2-wire, 120V only  D19 Phase dimming 1%, 120V only <sup>1,2</sup>		
							347V	For use with 347V only  D15 0-10V dim, 1% 347V only <sup>1,2</sup>		

1 Not available for Warm Glow  
2 Not available for Color Select

# TAKE THE NEXT STEP

**1 877 276 7876**

Customer Service Representatives  
7:45 a.m. to 5:00 p.m. EST Monday through Friday

**TechLine** – Technical information, detail drawings,  
CAD design assistance, installation information,  
other technical services – 8:00 a.m. to 5:30 p.m. EST,  
Monday through Friday. FAX 1 800 572 8324  
or email: [techline@armstrongceilings.com](mailto:techline@armstrongceilings.com)

**You Inspire™ Solutions Center**  
email: [solutionscenter@armstrongceilings.com](mailto:solutionscenter@armstrongceilings.com)  
[armstrongceilings.com/youinspire](http://armstrongceilings.com/youinspire)

**you inspire™**  
solutions center

helping to bring your one-of-a-kind ideas to life

**[armstrongceilings.com/commercial](http://armstrongceilings.com/commercial)**

Latest product news  
Standard and custom product information  
Online catalog  
CAD, Revit®, SketchUp® files  
A Ceiling for Every Space® Visual Selection Tool  
Product literature and samples – express service  
or regular delivery  
Contacts – reps, where to buy, who will install

Revit® is a registered trademark of Autodesk, Inc.; SketchUp® is a registered trademark of Trimble Navigation Limited;  
LEED® is a registered trademark of the U.S. Green Building Council.  
All other trademarks used herein are the property of AWI Licensing LLC and/or its affiliates  
© 2020 AWI Licensing LLC Printed in the United States of America

**[armstrongceilings.com/downlighting](http://armstrongceilings.com/downlighting)**

**Armstrong®**  
CEILING SOLUTIONS