



ACOUSTICAL ON-CENTER LINEAR LIGHTING

LAYOUT GUIDE

SYMMETRY IS BEAUTIFUL

Until now, incorporating on-center linear lighting into your ceiling layouts has been a challenge.

Now, Armstrong® can help you deliver your vision of a perfectly symmetrical, perfectly finished ceiling featuring on-center continuous or non-continuous linear lighting using factory-finished ceiling panels and suspension systems.

On-center continuous and non-continuous linear lighting layouts are easy to customize

armstrongceilings.com/linearlighing

- ESR-2311: ICC-ES Evaluation Report
- ESR-1289: ICC-ES Evaluation Report
- ES-0163: IAPMO seismic compliant with 2012 IBC
- Department of State Architect – DSA PA105
- City of LA – RR 5348
- 26 UL Fire Resistant Designs
- Meets ASTM C635, C841, C926, C636, C754, C840, and C842
- Meets ASTM C645 requirement for minimum metal thickness to .0179" for screw pullout

For more information, call 877 276-7876



ACOUSTICAL ON-CENTER LINEAR LIGHTING



Ultima® Beveled Tegular 24" x 24" panels with Silhouette® 1/4" reveal 9/16" suspension system and 4" linear light fixtures

ON CENTER LINEAR LIGHTING LAYOUT GUIDE

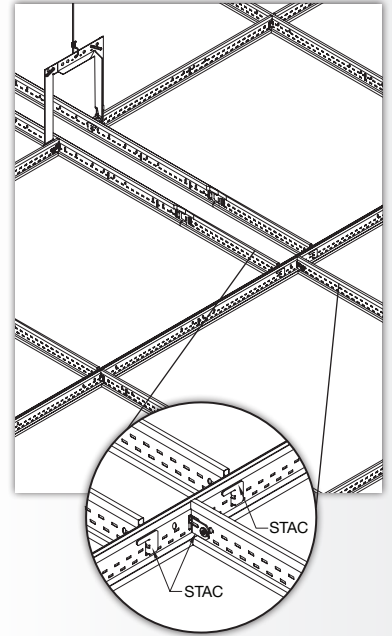

On-center Linear

Using a combination of Made-to-Order ceiling panels and suspension systems, perfect lighting layouts like this are easy to specify and install.

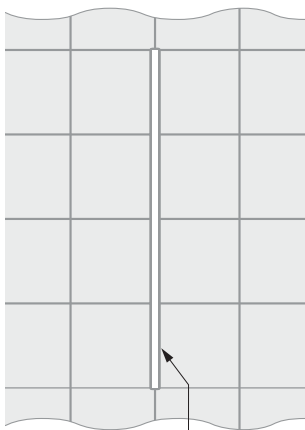

Opening for on-center linear light fixture placement

CONTINUOUS

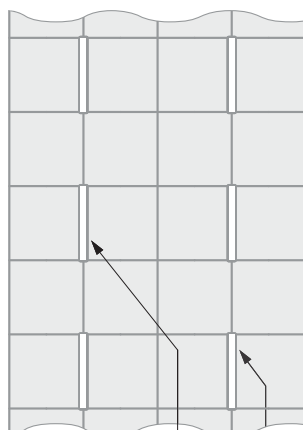

Opening for on-center linear light fixture placement

NON-CONTINUOUS

For more information, call 877 276-7876

ON-CENTER LINEAR LIGHTING

DESIGN YOUR LAYOUT

select from one of our standard layouts or create your own configuration

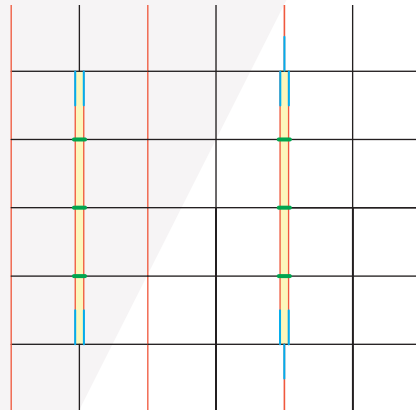

KEY:

- Main Beams
- Cross Tees
- Grid Adapter
- Lighting Connector Bracket or TechZone® Ceiling Systems Yoke
- Lights (suggested location)

CHOOSE YOUR FIELD PANELS, SUSPENSION SYSTEM, AND ACCESSORIES

MADE-TO-ORDER – CEILING PANELS AND SUSPENSION SYSTEMS

Made-to-Order ceiling panels are available to ship in 3 weeks with a one carton minimum and are perfect for designs where building modules are not standard, or if you'll be using narrow linear fixtures or diffusers. Now you can have crisp, clean panels and suspension system throughout your project.

- Popular textures, including Lyra®, Optima®, Calla®, and Ultima® (details below)
- Size capabilities by product:
 1. Lyra
 - 4"-11-1/2" wide and 6"-72" long
 - 12"-48" wide and 4"-96" long
 2. Calla
 - 4"-24-1/2" wide and 4"-72" long
 - 25"-35-1/2" wide and 4"-30" long
 - 36"-48" wide and 4"-24" long

3. Optima
 - 4"-11-1/2" wide and 6"-96" long
 - 12"-48" wide and 4"-120" long
4. Ultima
 - 4"-24-1/2" wide and 4"-72" long
 - 25"-48" wide and 4"-30" long
5. Suspension Systems
 - 36"-144" for main beams
 - 6"-144" for cross tees

*See data pages for more details

LYRA®, CALLA®

- Smooth drywall-like ceiling visual
- Outstanding acoustical performance
 - 0.95 NRC Lyra, 0.85 NRC Calla
- Part of the Sustain® portfolio



OPTIMA®, ULTIMA®

- Non-directional DuraBrite® surface for:
 - Excellent durability
 - Superior light reflectance to enhance daylighting and save energy
- Outstanding acoustical performance:
 - 0.90+ NRC Optima, 0.75 NRC Ultima

- Part of the Sustain® portfolio

ALL LYRA, OPTIMA, CALLA, AND ULTIMA PANELS ARE:



Item No.	Description	Dimensions (Inches)	Edge Profile	UL Classified Acoustics		Total Acoustics ¹	AC	Light Reflect	Sag Resistance	Recycling Program	Recycled Content
				NRC	CAC						
Square Tegular Panels											
□ 8361PB	Lyra®	24 x 24 x 1"		0.95	N/A	–	190	0.88	HumiGuard® Plus	Yes	Up to 71%
□ 3251	Optima®	24 x 24 x 1"		0.95	N/A	–	190	0.90	HumiGuard Plus	Yes	Up to 71%
□ 2824	Calla®	24 x 24 x 1"		0.85	35	BEST	170	0.86	HumiGuard Plus	Yes	77%
Beveled Tegular Panels											
□ 1912	Ultima®	24 x 24 x 3/4"		0.75	35	BETTER	N/A	0.90	HumiGuard Plus	Yes	Up to 84%

¹ Total Acoustics® ceiling panels have an ideal combination of noise reduction and sound-blocking performance in one product. **GOOD** (NRC 0.60-0.65; CAC 35+) **BETTER** (NRC 0.70-0.75; CAC 35+) **BEST** (NRC 0.80+; CAC 35+)

CHOOSE YOUR SUSPENSION SYSTEM

BELOW IS A SELECTION OF 9/16" MAIN BEAMS, CROSS TEES, AND MAIN BEAM TO CROSS TEE ADAPTERS CREATED TO SIMPLIFY COMMON ON-CENTER LIGHTING LAYOUTS

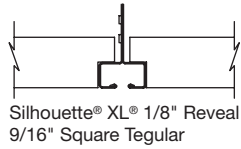

Silhouette® XL® 1/8" Reveal
9/16" Square Tegular

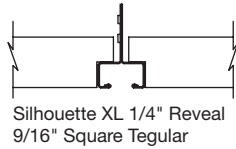

Silhouette XL 1/4" Reveal
9/16" Square Tegular

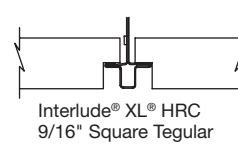

Interlude® XL® HRC
9/16" Square Tegular

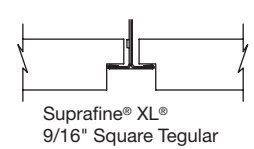

Suprafine® XL®
9/16" Square Tegular

Item No.	Description	Roof Spacing	Notching
Silhouette XL 1/8" Reveal 9/16" Slotted Tee Suspension System			
<input type="checkbox"/> 761238__	12' HD Main Beam – Notched 24" O.C. one side	12" O.C.	
<input type="checkbox"/> 761228__	10' HD Main Beam – Notched 24" O.C. one side	12" O.C.	
<input type="checkbox"/> 761218__	8' HD Main Beam – Notched 24" O.C. one side	12" O.C.	
<input type="checkbox"/> 761208__	6' HD Main Beam – Notched 24" O.C. one side	12" O.C.	
<input type="checkbox"/> 760238__	12' ID Main Beam – Notched 24" O.C. one side	12" O.C.	
<input type="checkbox"/> 760228__	10' ID Main Beam – Notched 24" O.C. one side	12" O.C.	
<input type="checkbox"/> 760218__	8' ID Main Beam – Notched 24" O.C. one side	12" O.C.	
<input type="checkbox"/> 760208__	6' ID Main Beam – Notched 24" O.C. one side	12" O.C.	

Cross Tees

<input type="checkbox"/> XL76898__	8' Cross Tee – Notched both sides at 24", 72", notched one side at 46", 50", and on opposite side at 48"	–	
<input type="checkbox"/> XL76498__	4' Cross Tee – Notched one side only at 22", 26" and on opposite side at 24"	–	
<input type="checkbox"/> XL76478__	46" Cross Tee – Notched both sides at 22"	–	
<input type="checkbox"/> XL76448__	44" Cross Tee – Center notched, both sides	–	
<input type="checkbox"/> XL76288__	28" Cross Tee – Unnotched	–	
<input type="checkbox"/> XL76228__	22" Cross Tee – Unnotched	–	

Grid Adapter

<input type="checkbox"/> GA76998__	1' Grid Adapter	–	
------------------------------------	-----------------	---	--

Silhouette XL 1/4" Reveal 9/16" Slotted Tee Suspension System

<input type="checkbox"/> 76123__	12' HD Main Beam – Notched 24" O.C. one side	12" O.C.	
<input type="checkbox"/> 76122__	10' HD Main Beam – Notched 24" O.C. one side	12" O.C.	
<input type="checkbox"/> 76121__	8' HD Main Beam – Notched 24" O.C. one side	12" O.C.	
<input type="checkbox"/> 76120__	6' HD Main Beam – Notched 24" O.C. one side	12" O.C.	
<input type="checkbox"/> 76023__	12' ID Main Beam – Notched 24" O.C. one side	12" O.C.	
<input type="checkbox"/> 76022__	10' ID Main Beam – Notched 24" O.C. one side	12" O.C.	
<input type="checkbox"/> 76021__	8' ID Main Beam – Notched 24" O.C. one side	12" O.C.	
<input type="checkbox"/> 76124__	6' ID Main Beam – Notched 24" O.C. one side	12" O.C.	

Cross Tees

<input type="checkbox"/> XL7689__	8' Cross Tee – Notched both sides at 24", 72", notched one side at 46", 50", and on opposite side at 48"	–	
<input type="checkbox"/> XL7649__	4' Cross Tee – Notched one side only at 22", 26" and on opposite side at 24"	–	
<input type="checkbox"/> XL7647__	46" Cross Tee – Notched both sides at 22"	–	
<input type="checkbox"/> XL7644__	44" Cross Tee – Center notched, both sides	–	
<input type="checkbox"/> XL7628__	28" Cross Tee – Unnotched	–	
<input type="checkbox"/> XL7622__	22" Cross Tee – Unnotched	–	

Grid Adapter

<input type="checkbox"/> GA7699__	1' Grid Adapter	–	
-----------------------------------	-----------------	---	--

Item No.	Description	Roof Spacing
Interlude XL HRC 9/16" Suspension System		
<input type="checkbox"/> 6126HRC__	10' HD Main Beam	6" O.C.
<input type="checkbox"/> 6125HRC__	8' HD Main Beam	6" O.C.
<input type="checkbox"/> 6124HRC__	6' HD Main Beam	6" O.C.
<input type="checkbox"/> 61026HRC__	10' ID Main Beam	6" O.C.
<input type="checkbox"/> 61025HRC__	8' ID Main Beam	6" O.C.
<input type="checkbox"/> 61024HRC__	6' ID Main Beam	6" O.C.

Cross Tees

<input type="checkbox"/> XL6189HRC__	8' Cross Tee	24", 46", 48", 50", 72"
<input type="checkbox"/> XL6149HRC__	4' Cross Tee	22", 24", 26"
<input type="checkbox"/> XL6147HRC__	46" Cross Tee	22"
<input type="checkbox"/> XL6144HRC__	44" Cross Tee	22"
<input type="checkbox"/> XL6128HRC__	28" Cross Tee	–
<input type="checkbox"/> XL6122HRC__	22" Cross Tee	–

Grid Adapter

<input type="checkbox"/> GA6199HRC__	9" and 15" Grid Adapters	–
--------------------------------------	--------------------------	---

Suprafine XL 9/16" Suspension System

<input type="checkbox"/> 7526__	10' HD Main Beam	6" O.C.
<input type="checkbox"/> 7525__	8' HD Main Beam	6" O.C.
<input type="checkbox"/> 7524__	6' HD Main Beam	6" O.C.
<input type="checkbox"/> 75026__	10' ID Main Beam	6" O.C.
<input type="checkbox"/> 75025__	8' ID Main Beam	6" O.C.
<input type="checkbox"/> 75024__	6' ID Main Beam	6" O.C.

Cross Tees

<input type="checkbox"/> XL7589__	8' Cross Tee	24", 46", 48", 50", 72"
<input type="checkbox"/> XL7543__	4' Cross Tee	22", 24", 26"
<input type="checkbox"/> XL7547__	46" Cross Tee	22"
<input type="checkbox"/> XL7544__	44" Cross Tee	22"
<input type="checkbox"/> XL7522__	22" Cross Tee	–

Grid Adapter

<input type="checkbox"/> GA7599__	9" and 15" Grid Adapters	–
-----------------------------------	--------------------------	---

Accessories

<input type="checkbox"/> LCB4	4" Lighting Connector Bracker	–
<input type="checkbox"/> TZYK	TechZone® Ceiling Systems Continuous Lighting Yoke (for 4" to 6" wide light fixtures)	–
<input type="checkbox"/> STAC	Single Tee Adapter Clip	–

ON-CENTER LINEAR LIGHTING

CLIPS AND ACCESSORIES FOR LIGHTING

LINEAR LIGHTING INTEGRATION – CLIPS AND ACCESSORIES

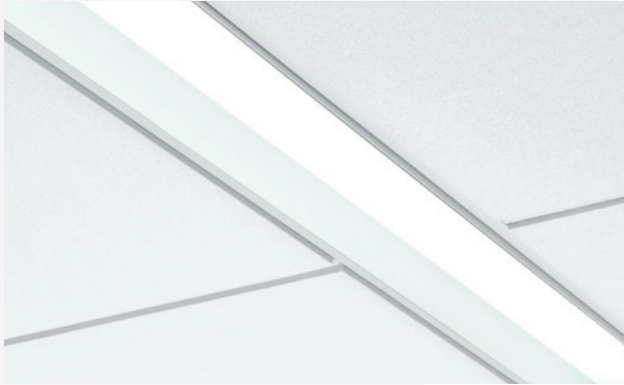

- The Zero Plenum Lighting Connector Bracket (LCB4) helps maintain the 4" wide suspension system opening, ensuring the XAL LENO or Axis Click fixture fits properly and securely into the ceiling opening.
- The LCB4 installs like a small cross tee, stabbing through the rout holes in the two perpendicular main beams and aligning with the two parallel cross tees.

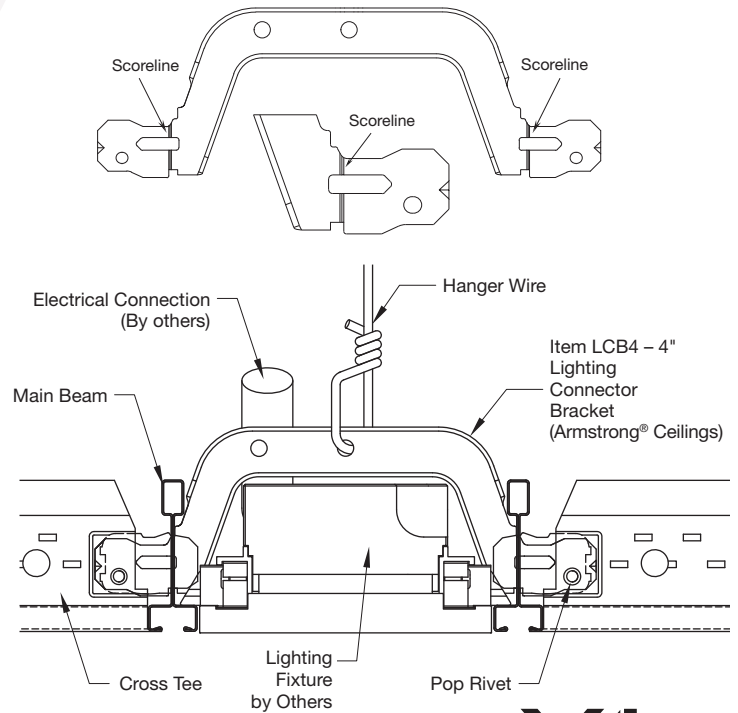

TECHZONE® CEILING SYSTEMS YOKE (TZYK)

- Create a sleek ceiling design with uninterrupted ribbons of light
- Alternate continuous lights and diffusers with other services for a monolithic, uncluttered visual
- Easy installation
- Seismic tested
- Ability to use with 4" and 6" configurations

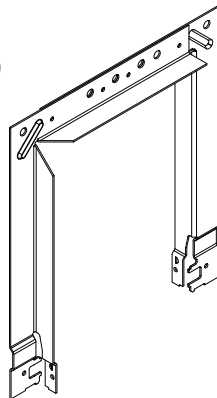

NOTE: 2 pieces per yoke assembly

TECHZONE CEILING SYSTEMS BRACING CLIP (TZBC)

Use to connect cross tees to the main beam of the continuous technical zone when no yoke is present.

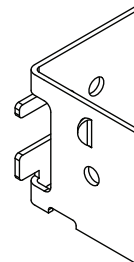

STAC CLIP

Allows you to create strong, code compliant, non-seismic and seismic D, E, F main beam-to-cross tee connections.

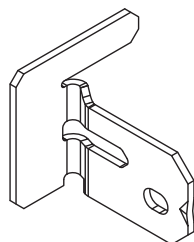



ON-CENTER LINEAR LIGHTING

CONTINUOUS LIGHT FIXTURE LAYOUT – 6' ON-CENTER

8' LINEAR LIGHTS WITH 9/16" SUSPENSION SYSTEM AND CEILING PANELS

FOR
INTERLUDE® XL®
HRC AND
SUPRAFINE®

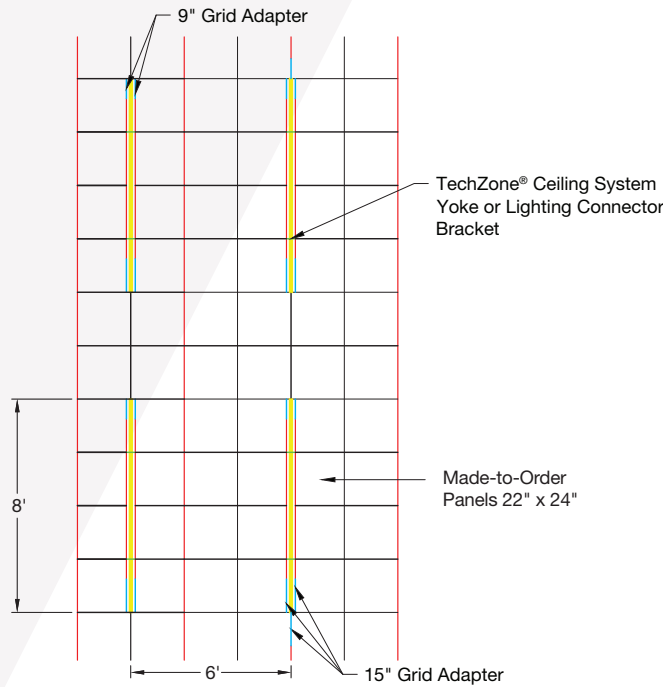

KEY:

- Main Beams
- Cross Tees
- Grid Adapter
- Lighting Connector Bracket or TechZone Ceiling Systems Yoke
- Lights (suggested location)

Item No.	Description	UL Classified Acoustics		Total Acoustics ¹	Light Reflect	Sag Resistance	Recycling Program	Recycled Content
		NRC	CAC					
Ceiling Panels*								
<input type="checkbox"/> 1912	Ultima® 24" x 24" Beveled Tegular	0.75	35	BETTER	0.90	HumiGuard® Plus	Yes	Up to 84%
<input type="checkbox"/>	Made-to-Order Sizes or Colors (2 Wks)	N/A	N/A	—	0.90	HumiGuard Plus	Yes	Up to 84%
NOTE: Up to 6 Weeks for Color & Size Combinations								

* For other ceiling panel options, refer to page 4.

¹ Total Acoustics® ceiling panels have an ideal combination of noise reduction and sound-blocking performance in one product. **GOOD** (NRC 0.60-0.65; CAC 35+) **BETTER** (NRC 0.70-0.75; CAC 35+) **BEST** (NRC 0.80+; CAC 35+)

Description	Interlude® XL® HRC	Suprafine®
Main Beams		
12' HD Main Beam Routs 6" O.C.	<input type="checkbox"/> 6101HRC	<input type="checkbox"/> 7501
6' HD Main Beam Routs 6" O.C.	<input type="checkbox"/> 6124HRC	<input type="checkbox"/> 7524
Cross Tees		
8' Cross Tee Routs at 24", 46", 48", 50", 72"	<input type="checkbox"/> XL6189HRC	<input type="checkbox"/> XL7589
4' Cross Tee Routs at 22", 24", 26"	<input type="checkbox"/> XL6149HRC	<input type="checkbox"/> XL7543
46" Cross Tee Routs at 22"	<input type="checkbox"/> XL6147HRC	<input type="checkbox"/> XL7547
22" Cross Tee	<input type="checkbox"/> XL6122HRC	<input type="checkbox"/> XL7522
Grid Adapter (9" and 15")	<input type="checkbox"/> GA6199HRC	<input type="checkbox"/> GA7599

Item No.	Description
Accessories	
<input type="checkbox"/> LCB4	4" Lighting Connector Bracket
<input type="checkbox"/> TZYK	TechZone® Ceiling Systems Continuous Lighting Yoke (for 4" to 6" wide light fixtures)
<input type="checkbox"/> STAC	Single Tee Adapter Clip

CONTINUOUS LIGHT FIXTURE LAYOUT – 6' ON-CENTER

8' LINEAR LIGHTS WITH 9/16" SUSPENSION SYSTEM AND CEILING PANELS

FOR
SILHOUETTE®
1/4" AND 1/8"
REVEAL

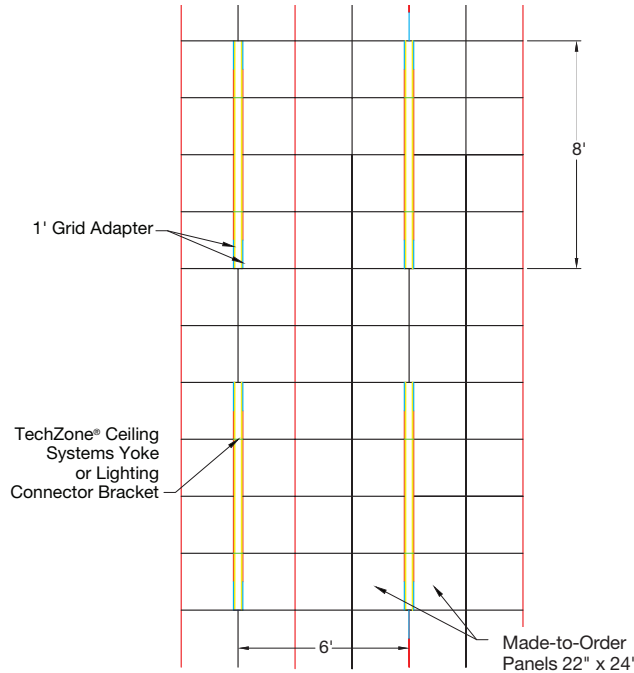

KEY:

- Main Beams
- Cross Tees
- Grid Adapter
- Lighting Connector Bracket or TechZone Ceiling Systems Yoke
- Lights (suggested location)

Item No.	Description	UL Classified Acoustics		Total Acoustics ¹	Light Reflect	Sag Resistance	Recycling Program	Recycled Content
		NRC	CAC					
<input type="checkbox"/> 1912	Ultima® 24" x 24" Beveled Tegular	0.75	35	BETTER	0.90	HumiGuard® Plus	Yes	Up to 84%
<input type="checkbox"/>	Made-to-Order Sizes or Colors (2 Wks) NOTE: Up to 6 Weeks for Color & Size Combinations	N/A	N/A	–	0.90	HumiGuard Plus	Yes	Up to 84%

* For other ceiling panel options, refer to page 4.

¹ Total Acoustics® ceiling panels have an ideal combination of noise reduction and sound-blocking performance in one product. **GOOD** (NRC 0.60-0.65; CAC 35+) **BETTER** (NRC 0.70-0.75; CAC 35+) **BEST** (NRC 0.80+; CAC 35+)

Description	Silhouette® 1/4"	Silhouette 1/8"	Silhouette Notes
Main Beams			
12' HD Main Beam Routs 6" O.C.	<input type="checkbox"/> 76123	<input type="checkbox"/> 761238	Routs 12" O.C., Single Notch 24" O.C.
6' HD Main Beam Routs 6" O.C.	<input type="checkbox"/> 76120	<input type="checkbox"/> 761208	Routs 12" O.C., Single Notch 24" O.C.
Cross Tees			
8' Cross Tee Routs at 24", 46", 48", 50", 72"	<input type="checkbox"/> XL7689	<input type="checkbox"/> XL76898	Routs 12" O.C., Double Notch at 24", 72", notched one side at 46", 50", and on opposite side at 48"
4' Cross Tee Routs at 22", 24", 26"	<input type="checkbox"/> XL7649	<input type="checkbox"/> XL76498	Notched one side only at 22", 26", and on opposite side at 24"
46" Cross Tee Routs at 22"	<input type="checkbox"/> XL7647	<input type="checkbox"/> XL76478	Double Notch at 22"
22" Cross Tee	<input type="checkbox"/> XL7622	<input type="checkbox"/> XL76228	Unnotched
Grid Adapter (1')	<input type="checkbox"/> GA7699	<input type="checkbox"/> GA76998	Unnotched

Item No.	Description
<input type="checkbox"/> LCB4	4" Lighting Connector Bracket
<input type="checkbox"/> TZYK	TechZone® Ceiling Systems Continuous Lighting Yoke (for 4" to 6" wide light fixtures)
<input type="checkbox"/> STAC	Single Tee Adapter Clip

ON-CENTER LINEAR LIGHTING

CONTINUOUS LIGHT FIXTURE LAYOUT – 8' ON-CENTER

18' LINEAR LIGHTS WITH 9/16" SUSPENSION SYSTEM AND CEILING PANELS

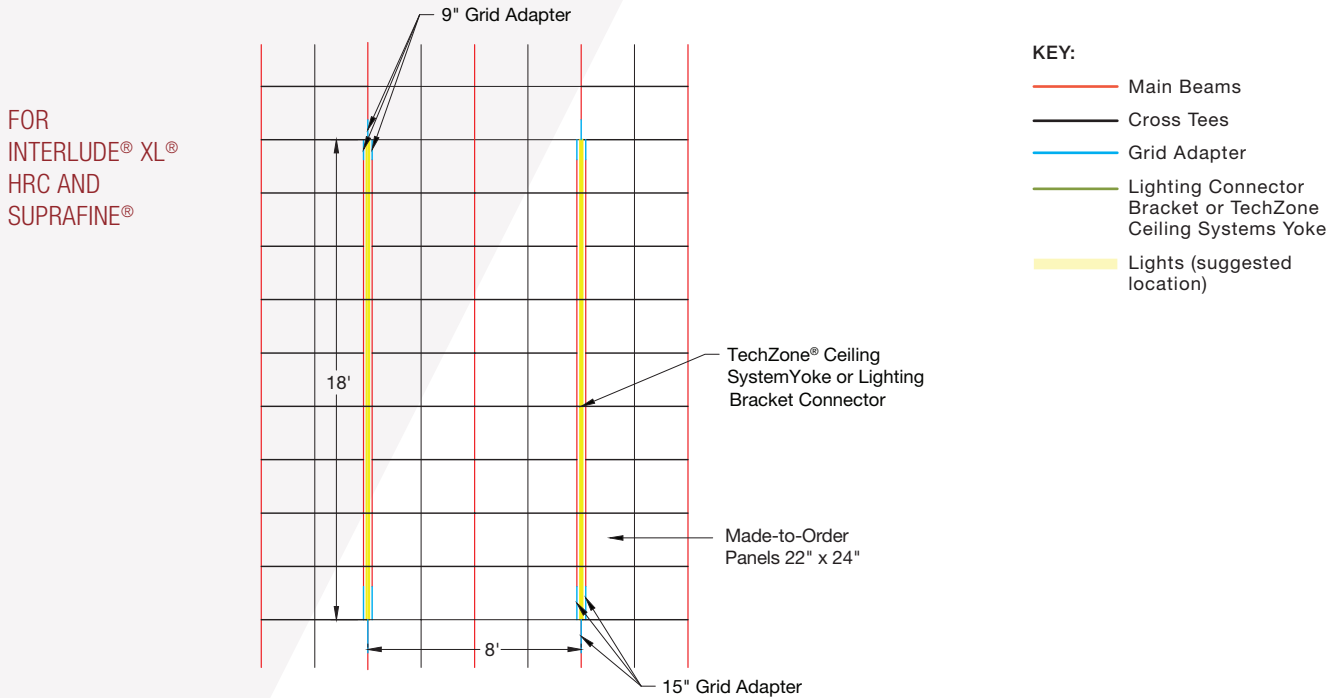

Item No.	Description	UL Classified Acoustics		Total Acoustics ¹	Light Reflect	Sag Resistance	Recycling Program	Recycled Content
		NRC	CAC					
Ceiling Panels*								
<input type="checkbox"/> 1912	Ultima® 24" x 24" Beveled Tegular	0.75	35	BETTER	0.90	HumiGuard® Plus	Yes	Up to 84%
<input type="checkbox"/>	Made-to-Order Sizes or Colors (2 Wks)	N/A	N/A	-	0.90	HumiGuard Plus	Yes	Up to 84%
NOTE: Up to 6 Weeks for Color & Size Combinations								

* For other ceiling panel options, refer to page 4.

¹ Total Acoustics® ceiling panels have an ideal combination of noise reduction and sound-blocking performance in one product. **GOOD** (NRC 0.60-0.65; CAC 35+) **BETTER** (NRC 0.70-0.75; CAC 35+) **BEST** (NRC 0.80+; CAC 35+)

Description	Interlude® XL® HRC	Suprafine®
Main Beams		
12' HD Main Beam Routs 6" O.C.	<input type="checkbox"/> 6101HRC	<input type="checkbox"/> 7501
8' HD Main Beam Routs 6" O.C.	<input type="checkbox"/> 6125HRC	<input type="checkbox"/> 7525
Cross Tees		
8' Cross Tee Routs at 24", 46", 48", 50", 72"	<input type="checkbox"/> XL6189HRC	<input type="checkbox"/> XL7589
46" Cross Tee Routs at 22"	<input type="checkbox"/> XL6147HRC	<input type="checkbox"/> XL7547
24" Cross Tee	<input type="checkbox"/> XL6120HRC	<input type="checkbox"/> XL7520
Grid Adapter (9" and 15")	<input type="checkbox"/> GA6199HRC	<input type="checkbox"/> GA7599

Item No.	Description
Accessories	
<input type="checkbox"/> LCB4	4" Lighting Connector Bracket
<input type="checkbox"/> TZYK	TechZone® Ceiling Systems Continuous Lighting Yoke (for 4" to 6" wide light fixtures)
<input type="checkbox"/> STAC	Single Tee Adapter Clip

CONTINUOUS LIGHT FIXTURE LAYOUT – 8' ON-CENTER

18' LINEAR LIGHTS WITH 9/16" SUSPENSION SYSTEM AND CEILING PANELS

FOR
SILHOUETTE®
1/4" AND 1/8"
REVEAL

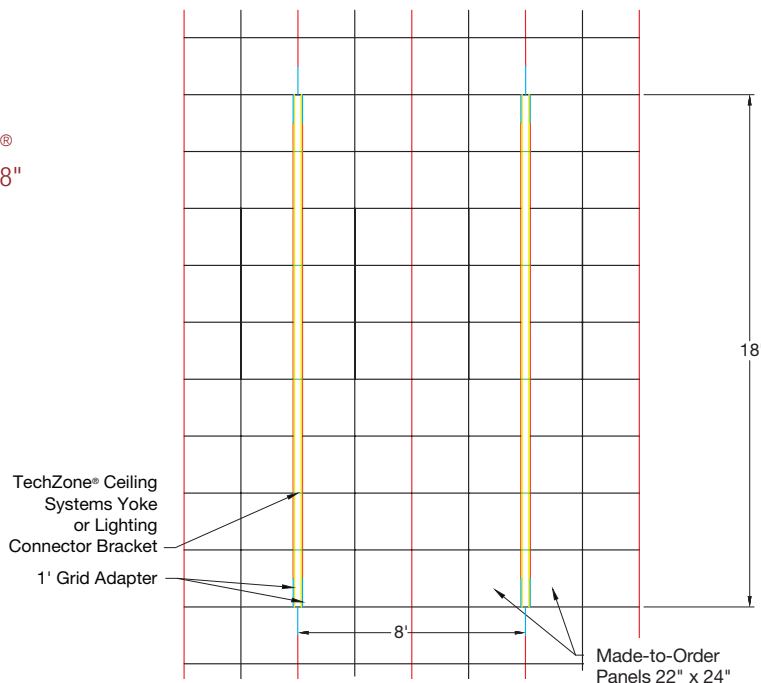

KEY:

- Main Beams
- Cross Tees
- Grid Adapter
- Lighting Connector Bracket or TechZone Ceiling Systems Yoke
- Lights (suggested location)

Item No.	Description	UL Classified Acoustics		Total Acoustics ¹	Light Reflect	Sag Resistance	Recycling Program	Recycled Content
		NRC	CAC					
<input type="checkbox"/> 1912	Ultima® 24" x 24" Beveled Tegular	0.75	35	BETTER	0.90	HumiGuard® Plus	Yes	Up to 84%
<input type="checkbox"/>	Made-to-Order Sizes or Colors (2 Wks) NOTE: Up to 6 Weeks for Color & Size Combinations	N/A	N/A	–	0.90	HumiGuard Plus	Yes	Up to 84%

* For other ceiling panel options, refer to page 4.

¹ Total Acoustics® ceiling panels have an ideal combination of noise reduction and sound-blocking performance in one product. **GOOD** (NRC 0.60-0.65; CAC 35+) **BETTER** (NRC 0.70-0.75; CAC 35+) **BEST** (NRC 0.80+; CAC 35+)

Description	Silhouette® 1/4"	Silhouette 1/8"	Silhouette Notes
Main Beams			
12' HD Main Beam Routs 6" O.C.	<input type="checkbox"/> 76123	<input type="checkbox"/> 761238	Routs 12" O.C., Single Notch 24" O.C.
8' HD Main Beam Routs 6" O.C.	<input type="checkbox"/> 76121	<input type="checkbox"/> 761218	Routs 12" O.C., Single Notch 24" O.C.
Cross Tees			
8' Cross Tee Routs at 24", 46", 48", 50", 72"	<input type="checkbox"/> XL7689	<input type="checkbox"/> XL76898	Routs 12" O.C., Double Notch at 24", 72", notched one side at 46", 50", and on opposite side at 48"
46" Cross Tee Routs at 22"	<input type="checkbox"/> XL7647	<input type="checkbox"/> XL76478	Double Notch at 22"
24" Cross Tee	<input type="checkbox"/> XL7620	<input type="checkbox"/> XL76208	Unnotched
Grid Adapter (1')	<input type="checkbox"/> GA7699	<input type="checkbox"/> GA76998	Unnotched

Item No.	Description
Accessories	
<input type="checkbox"/> LCB4	4" Lighting Connector Bracket
<input type="checkbox"/> TZYK	TechZone® Ceiling Systems Continuous Lighting Yoke (for 4" to 6" wide light fixtures)
<input type="checkbox"/> STAC	Single Tee Adapter Clip

ON-CENTER LINEAR LIGHTING

CONTINUOUS LIGHT FIXTURE LAYOUT – 10' ON-CENTER

16' LINEAR LIGHTS WITH 9/16" SUSPENSION SYSTEM AND CEILING PANELS

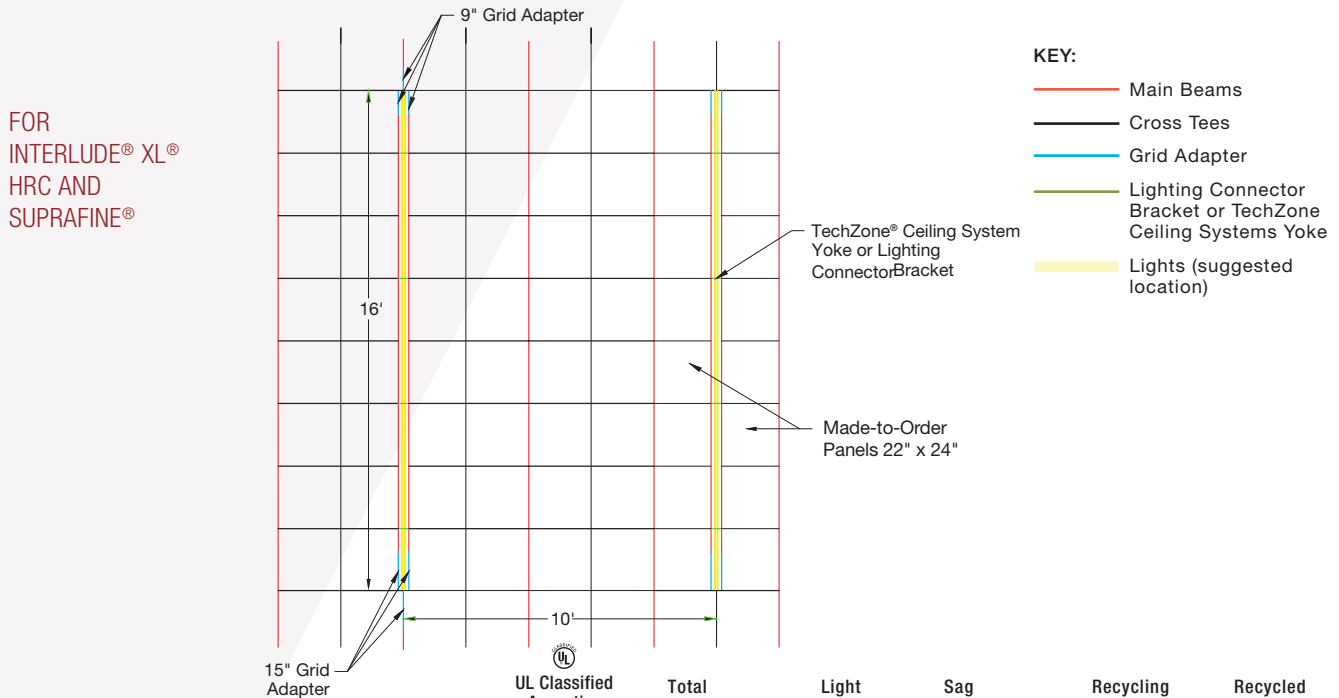

FOR
INTERLUDE® XL®
HRC AND
SUPRAFINE®

- KEY:**
- Main Beams
 - Cross Tees
 - Grid Adapter
 - Lighting Connector Bracket or TechZone Ceiling Systems Yoke
 - Lights (suggested location)

Item No.	Description	UL Classified Acoustics		Total Acoustics ¹	Light Reflect	Sag Resistance	Recycling Program	Recycled Content
		NRC	+ CAC	= NRC + CAC				
Ceiling Panels*								
<input type="checkbox"/> 1912	Ultima® 24" x 24" Beveled Tegular	0.75	35	BETTER	0.90	HumiGuard® Plus	Yes	Up to 84%
<input type="checkbox"/>	Made-to-Order Sizes or Colors (2 Wks) 1 CTN MIN	N/A	N/A	–	0.90	HumiGuard Plus	Yes	Up to 84%
	NOTE: Up to 6 Weeks for Color & Size Combinations							

* For other ceiling panel options, refer to page 4.
¹ Total Acoustics® ceiling panels have an ideal combination of noise reduction and sound-blocking performance in one product. **GOOD** (NRC 0.60-0.65; CAC 35+) **BETTER** (NRC 0.70-0.75; CAC 35+) **BEST** (NRC 0.80+; CAC 35+)

Description	Interlude® XL® HRC	Suprafine®
Main Beams		
12' HD Main Beam Routs 6" O.C.	<input type="checkbox"/> 6101HRC	<input type="checkbox"/> 7501
8' HD Main Beam Routs 6" O.C.	<input type="checkbox"/> 6125HRC	<input type="checkbox"/> 7525
6' HD Main Beam Routs 6" O.C.	<input type="checkbox"/> 6124HRC	<input type="checkbox"/> 7524
Cross Tees		
8' Cross Tee Routs at 24", 46", 48", 50", 72"	<input type="checkbox"/> XL6189HRC	<input type="checkbox"/> XL7589
4' Cross Tee Routs at 22", 24", 26"	<input type="checkbox"/> XL6149HRC	<input type="checkbox"/> XL7543
46" Cross Tee Routs at 22"	<input type="checkbox"/> XL6147HRC	<input type="checkbox"/> XL7547
24" Cross Tee	<input type="checkbox"/> XL6120HRC	<input type="checkbox"/> XL7520
22" Cross Tee	<input type="checkbox"/> XL6122HRC	<input type="checkbox"/> XL7522
Grid Adapter (9" and 15")	<input type="checkbox"/> GA6199HRC	<input type="checkbox"/> GA7599

Item No.	Description
Accessories	
<input type="checkbox"/> LCB4	4" Lighting Connector Bracket
<input type="checkbox"/> TZYK	TechZone® Ceiling Systems Continuous Lighting Yoke (for 4" to 6" wide light fixtures)
<input type="checkbox"/> STAC	Single Tee Adapter Clip

CONTINUOUS LIGHT FIXTURE LAYOUT – 10' ON-CENTER

16' LINEAR LIGHTS WITH 9/16" SUSPENSION SYSTEM AND CEILING PANELS

FOR
SILHOUETTE®
1/4" AND 1/8"
REVEAL

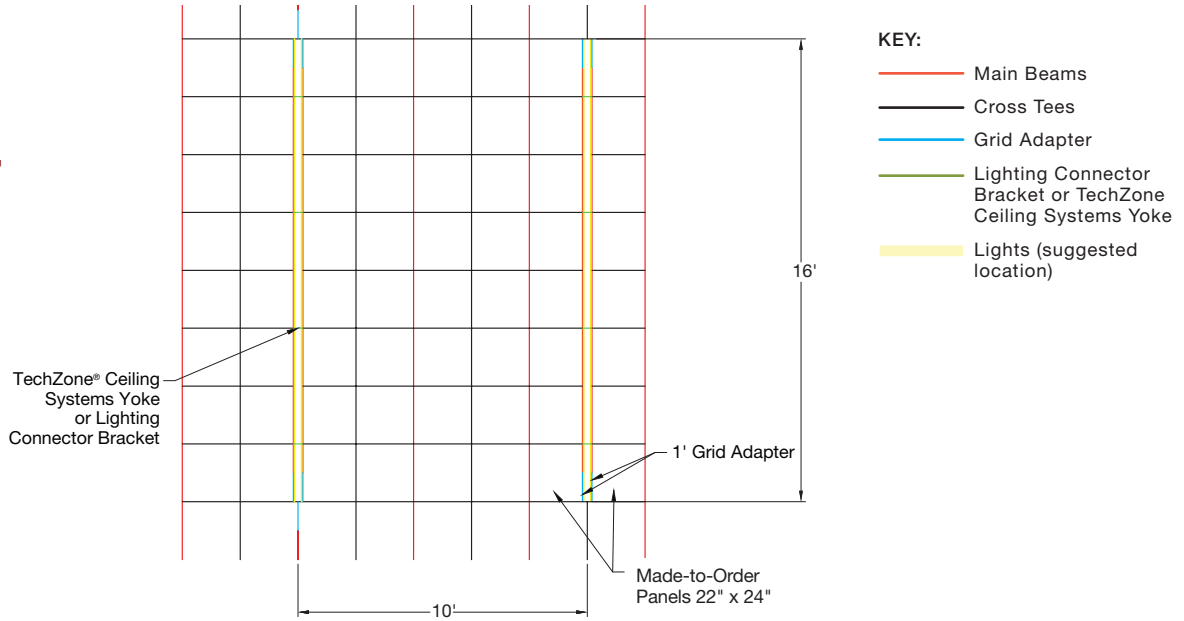

Item No.	Description	UL Classified Acoustics		Total Acoustics ¹	Light Reflect	Sag Resistance	Recycling Program	Recycled Content
		NRC	+ CAC					
<input type="checkbox"/> 1912	Ultima® 24" x 24" Beveled Tegular	0.75	35	BETTER	0.90	HumiGuard® Plus	Yes	Up to 84%
<input type="checkbox"/>	<div style="border: 1px solid black; padding: 2px; display: inline-block;"> 1 CTN MIN Made-to-Order Sizes or Colors (2 Wks) </div> Ultima 22" x 24" NOTE: Up to 6 Weeks for Color & Size Combinations	N/A	N/A	–	0.90	HumiGuard Plus	Yes	Up to 84%

* For other ceiling panel options, refer to page 4.

¹ Total Acoustics® ceiling panels have an ideal combination of noise reduction and sound-blocking performance in one product. **GOOD** (NRC 0.60-0.65; CAC 35+) **BETTER** (NRC 0.70-0.75; CAC 35+) **BEST** (NRC 0.80+; CAC 35+)

Description	Silhouette® 1/4"	Silhouette 1/8"	Silhouette Notes
Main Beams			
12' HD Main Beam Routs 6" O.C.	<input type="checkbox"/> 76123	<input type="checkbox"/> 761238	Routs 12" O.C., Single notch 24" O.C.
8' HD Main Beam Routs 6" O.C.	<input type="checkbox"/> 76121	<input type="checkbox"/> 761218	Routs 12" O.C., Single notch 24" O.C.
6' HD Main Beam Routs 6" O.C.	<input type="checkbox"/> 76120	<input type="checkbox"/> 761208	Routs 12" O.C., Single notch 24" O.C.
Cross Tees			
8" Cross Tee Routs at 24", 46", 48", 50", 72"	<input type="checkbox"/> XL7689	<input type="checkbox"/> XL76898	Routs 12" O.C., Double Notch at 24", 72", notched one side at 46", 50" and on opposite side at 48"
4" Cross Tee Routs at 22", 24", 26"	<input type="checkbox"/> XL7649	<input type="checkbox"/> XL76498	Notched one side only at 22", 26" and on opposite side at 24"
46" Cross Tee Routs at 22"	<input type="checkbox"/> XL7647	<input type="checkbox"/> XL76478	Double Notch at 22"
24" Cross Tee	<input type="checkbox"/> XL7620	<input type="checkbox"/> XL76208	Unnotched
22" Cross Tee	<input type="checkbox"/> XL7622	<input type="checkbox"/> XL76228	Unnotched
Grid Adapter (1')	<input type="checkbox"/> GA7699	<input type="checkbox"/> GA76998	Unnotched

Item No.	Description
Accessories	
<input type="checkbox"/> LCB4	4" Lighting Connector Bracket
<input type="checkbox"/> TZYK	TechZone® Ceiling Systems Continuous Lighting Yoke (for 4" to 6" wide light fixtures)
<input type="checkbox"/> STAC	Single Tee Adapter Clip

ON-CENTER LINEAR LIGHTING

DISCONTINUOUS LIGHT FIXTURE LAYOUT – 6' ON-CENTER

4' LINEAR LIGHTS WITH 9/16" SUSPENSION SYSTEM AND CEILING PANELS

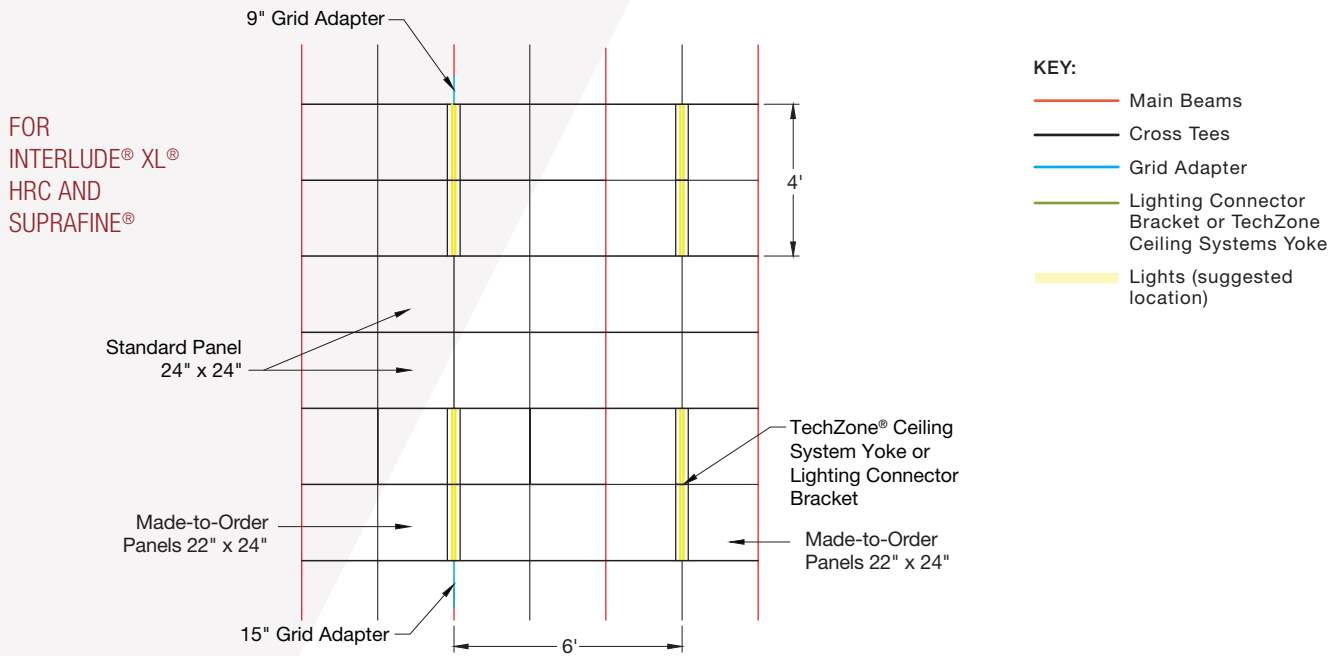

Item No.	Description	UL Classified Acoustics		Total Acoustics ¹	Light Reflect	Sag Resistance	Recycling Program	Recycled Content
		NRC	CAC					
Ceiling Panels*								
<input type="checkbox"/> 1912	Ultima® 24" x 24" Beveled Tegular	0.75	35	BETTER	0.90	HumiGuard® Plus	Yes	Up to 84%
<input type="checkbox"/>	Made-to-Order Sizes or Colors (2 Wks) Ultima 22" x 24"	N/A	N/A	–	0.90	HumiGuard Plus	Yes	Up to 84%

* For other ceiling panel options, refer to page 4.

¹ Total Acoustics® ceiling panels have an ideal combination of noise reduction and sound-blocking performance in one product. **GOOD** (NRC 0.60-0.65; CAC 35+) **BETTER** (NRC 0.70-0.75; CAC 35+) **BEST** (NRC 0.80+; CAC 35+)

Description	Interlude®	Suprafine®
Main Beams		
12' HD Main Beam Routs 6" O.C.	<input type="checkbox"/> 6101HRC	<input type="checkbox"/> 7501
Cross Tees		
8' Cross Tee Routs at 24", 46", 48", 50", 72"	<input type="checkbox"/> XL6189HRC	<input type="checkbox"/> XL7589
4' Cross Tee Routs at 22", 24", 26"	<input type="checkbox"/> XL6149HRC	<input type="checkbox"/> XL7543
48" Cross Tee Routs at 24"	<input type="checkbox"/> XL6140HRC	<input type="checkbox"/> XL7540
46" Cross Tee Routs at 22"	<input type="checkbox"/> XL6147HRC	<input type="checkbox"/> XL7547
24" Cross Tee	<input type="checkbox"/> XL6120HRC	<input type="checkbox"/> XL7520
22" Cross Tee	<input type="checkbox"/> XL6122HRC	<input type="checkbox"/> XL7522
Grid Adapter	<input type="checkbox"/> GA6199HRC	<input type="checkbox"/> GA7599

Item No.	Description
Accessories	
<input type="checkbox"/> LCB4	4" Lighting Connector Bracket
<input type="checkbox"/> TZYK	TechZone® Ceiling Systems Continuous Lighting Yoke (for 4" to 6" wide light fixtures)
<input type="checkbox"/> STAC	Single Tee Adapter Clip

DISCONTINUOUS LIGHT FIXTURE LAYOUT – 6' ON-CENTER

4' LINEAR LIGHTS WITH 9/16" SUSPENSION SYSTEM AND CEILING PANELS

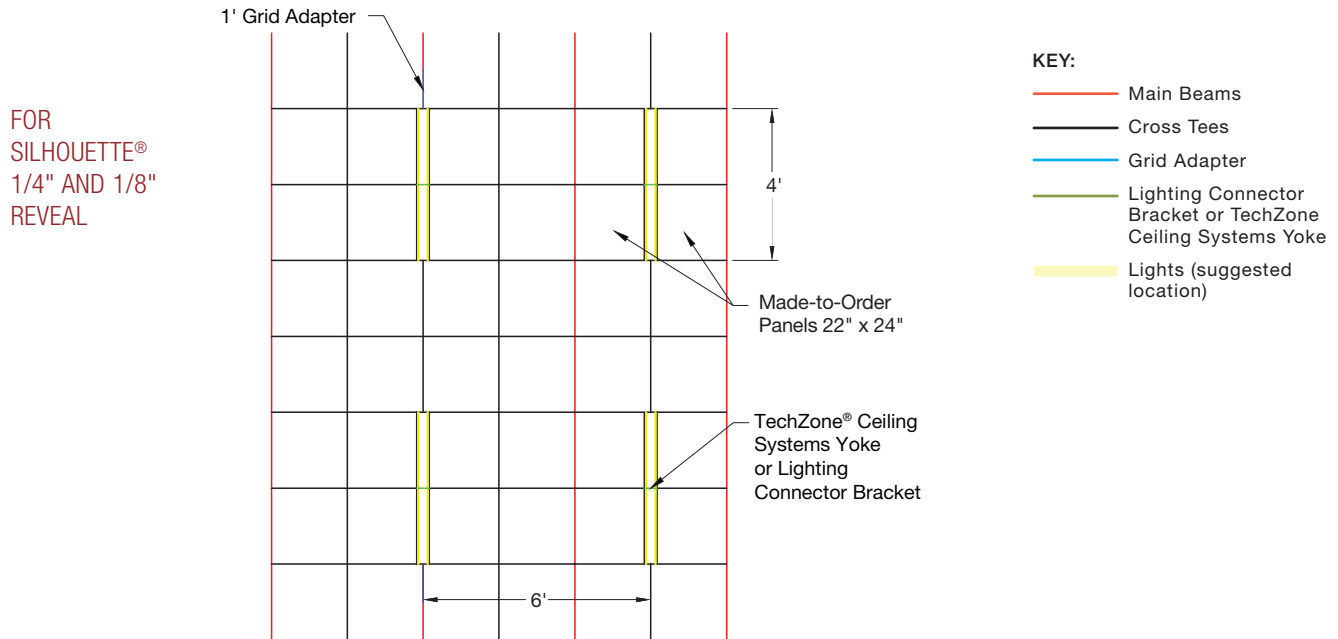

Item No.	Description	UL Classified Acoustics			Total Acoustics ¹	Light Reflect	Sag Resistance	Recycling Program	Recycled Content
		NRC	+	CAC					
Ceiling Panels*									
<input type="checkbox"/> 1912	Ultima® 24" x 24" Beveled Tegular	0.75		35	BETTER	0.90	HumiGuard® Plus	Yes	Up to 84%
<input type="checkbox"/>	1 CTN MIN Made-to-Order Sizes or Colors (2 Wks) Ultima 22" x 24" NOTE: Up to 6 Weeks for Color & Size Combinations	N/A		N/A	–	0.90	HumiGuard Plus	Yes	Up to 84%

* For other ceiling panel options, refer to page 4.

¹ Total Acoustics® ceiling panels have an ideal combination of noise reduction and sound-blocking performance in one product. **GOOD** (NRC 0.60-0.65; CAC 35+) **BETTER** (NRC 0.70-0.75; CAC 35+) **BEST** (NRC 0.80+; CAC 35+)

Description	Silhouette® 1/4"	Silhouette 1/8"	Silhouette Notes
Main Beams			
12' HD Main Beam Routs 6" O.C.	<input type="checkbox"/> 76123	<input type="checkbox"/> 761238	Routs 12" O.C., Single notch 24" O.C.
Cross Tees			
8' Cross Tee Routs at 24", 46", 48", 50", 72"	<input type="checkbox"/> XL7689	<input type="checkbox"/> XL76898	Routs 12" O.C., Double Notch at 24", 72", notched one side at 46", 50", and on opposite side at 48"
4' Cross Tee Routs at 22", 24", 26"	<input type="checkbox"/> XL7649	<input type="checkbox"/> XL76498	Routs 12" O.C., Double Notch at 22", 26", and on opposite side at 24"
48" Cross Tee Routs at 24"	<input type="checkbox"/> XL7646	<input type="checkbox"/> XL76468	Single Notch 24" O.C.
46" Cross Tee Routs at 22"	<input type="checkbox"/> XL7647	<input type="checkbox"/> XL76478	Double Notch at 22"
24" Cross Tee	<input type="checkbox"/> XL7620	<input type="checkbox"/> XL76208	Unnotched
22" Cross Tee	<input type="checkbox"/> XL7622	<input type="checkbox"/> XL76228	Unnotched
Grid Adapter	<input type="checkbox"/> GA7699	<input type="checkbox"/> GA76998	Unnotched

Item No.	Description
Accessories	
<input type="checkbox"/> LCB4	4" Lighting Connector Bracket
<input type="checkbox"/> TZYK	TechZone® Ceiling Systems Continuous Lighting Yoke (for 4" to 6" wide light fixtures)
<input type="checkbox"/> STAC	Single Tee Adapter Clip

TAKE THE NEXT STEP

877 276-7876

Customer Service Representatives
7:45 a.m. to 5:00 p.m. EST
Monday through Friday

TechLine – Technical information, detail drawings,
CAD design assistance, installation information,
other technical services – 8:00 a.m. to 5:30 p.m. EST,
Monday through Friday. FAX 1 800 572 8324
or email: techline@armstrongceilings.com

armstrongceilings.com/commercial

Latest product news
Standard and custom product information
Online catalog
CAD, Revit®, SketchUp® files
A Ceiling for Every Space® Visual Selection Tool
Product literature and samples – express service
or regular delivery
Contacts – reps, where to buy, who will install

YOU INSPIRE™ SOLUTIONS CENTER

email: solutionscenter@armstrongceilings.com
armstrongceilings.com/youinspire

Design Assistance

Collaborative design
Detail drawings
Specifications
Planning and budgeting

Pre-construction Assistance

Layout drawings for standard
and premium products
Project installation recommendations
Contractor installation assistance

Centre de solutions
you inspire^{MC}

pour donner vie aux idées qui vous ressemblent

LEED is a registered trademark of the U.S. Green Building Council
SketchUp® is a registered trademark of Trimble Navigation Limited
Revit® is a registered trademark of Autodesk, Inc.; XAL is owned by XAL, LLC
All other trademarks used herein are the property of AWI Licensing LLC and/or its affiliates
© 2019 AWI Licensing LLC • Printed in the United States of America

TechLine / 877 276-7876
armstrongceilings.com/linearlighting

**Armstrong**[®]
CEILING SOLUTIONS