



# TECHZONE®

CEILING SYSTEMS  
SELECTION GUIDE

# ORGANIZED. SIMPLE. CLEAN.

Leave the “noise” behind – the clutter of lighting, air diffusers and returns, sprinkler systems, and unwanted sound – that busy the ceiling plane. TechZone® easily organizes these systems into 4", 6", or 12" wide technical zones.

A range of compatible fixtures from our partner companies have been prequalified for fit and finish.

The result – a clean, monolithic look, using standard ceiling panels and suspension systems.

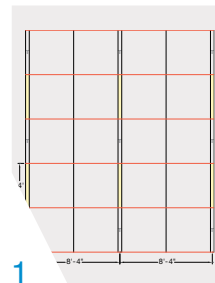

1

Design Your  
Layout



2

Choose Your  
Field Panels





# TECHZONE® CEILING SYSTEMS

## TABLE OF CONTENTS

- 2-3 Choose Your Own Ceiling System
- 4-6 Field Panels
  - 7 Technical Panels
- 8-9 Suspension Systems
  - 10 Perimeter Treatment
  - 11 TechZone® Partners
  - 12 Accessories
- 13-15 System Layout and Components



3

Choose Your  
Technical Panels



4

Choose a Compatible  
Suspension System



5

Choose Your Perimeter  
Treatment, Moldings,  
and Accessories

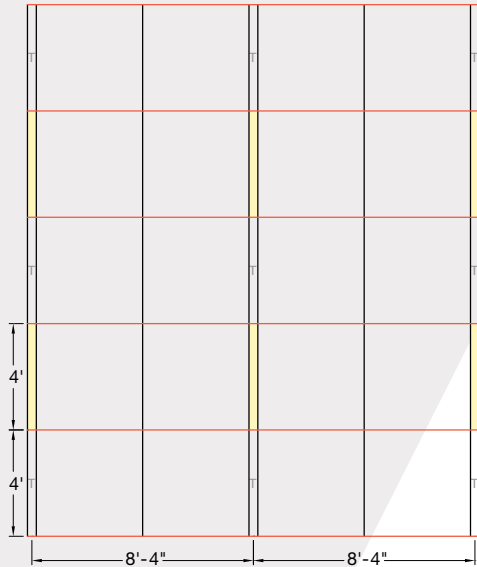

# FIELD PANELS

## DESIGN YOUR LAYOUT



Select from one of the many layouts in our CAD/Revit library, or create your own configuration.

KEY:

-  Main Beams
-  Cross Tees
-  Lights (suggested location)

## CHOOSE YOUR FIELD PANELS

### LYRA® PB, CALLA®

- Smooth drywall-like ceiling visual
  - Coordinates with Blizzard White suspension system and Axiom® trim
  - High light reflectance
  - High durability
- Outstanding acoustical performance
  - Reduces reverberation
  - Enhances speech privacy
  - 0.95 NRC Lyra PB, 0.85 NRC Calla
- Part of the Sustain™ portfolio, and meets the most stringent industry sustainability compliance standards today



### OPTIMA®, ULTIMA®

- Non-directional DuraBrite® surface for:
  - Excellent durability
  - Superior light reflectance to enhance daylighting and save energy
- Outstanding acoustical performance:
  - Reduces noise reverberation
  - Enhances speech privacy in open plan environments
  - 0.90+ NRC Optima, 0.70 NRC Ultima
- Vector® panel options for semi-concealed visual

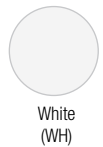

### WOODWORKS®

- Warm, rich FSC® Certified wood in five standard finishes
- BioAcoustic™ infill panels enhance acoustics
- 0.40 NRC with W2 perforation and infill panel
- CleanAssure™ family of products – includes disinfectable panels, suspension systems, and trim

#### Natural Variations™ (Real Wood Veneers)

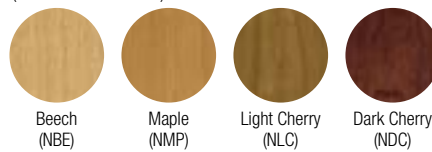

#### Perforation options:

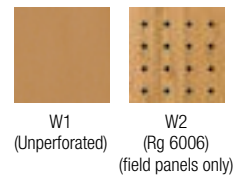



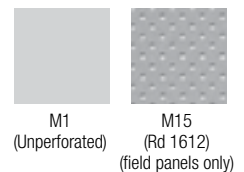

### METALWORKS™

- Three standard finishes for field and technical panels
- Fleece-backed perforated panels provide outstanding acoustics
  - 0.70 NRC standard, 0.90 NRC with infill panel
- Aluminum panels with exceptional durability
  - Washable, Scrubbable, Soil-resistant
- Part of the Sustain™ portfolio, and meets the most stringent industry sustainability compliance standards today

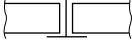

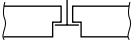
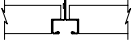
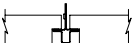
## ITEM NUMBERS AT-A-GLANCE

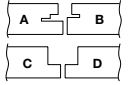
Suspension Dimension	Edge Profile	Dimensions	Lyra® PB	Optima®	Calla®	Ultima®	WoodWorks® Unperforated	WoodWorks® Perforated	MetalWorks™ Unperforated	MetalWorks™ Perforated	
			Item Numbers								
15/16"	Prelude® XL® Square Lay-In 	20" x 60"		3156†							
		24" x 24"		3152†/3150**†	2820	1910† + Create!					
		24" x 48"		3153†/3151**†	2821	1913†					
		24" x 60"		3164**†		1984†					
		24" x 72"	8450PB	3161**†		1980†					
		24" x 96"		3162**†							
		30" x 30"	8452PB	3158†		1905†					
		30" x 60"	8453PB	3157†							
		48" x 48"	8370PB	3160†							
48" x 96"		3154									
15/16"	Prelude XL Square Tegular 	20" x 60"		3278†							
		24" x 24"	8360PB	3250†	2822						
		24" x 48"	8352PB	3252†	2823						
		24" x 72"		3281†							
		24" x 96"		3282†							
		30" x 30"		3258†							
		30" x 60"		3286†							
48" x 48"	8355PB	3255†									
15/16"	Prelude XL Beveled Tegular 	24" x 24"				1911†					
		24" x 48"				1914†					
		24" x 60"				1985†					
		24" x 72"				1981†					
9/16"	Suprafine® XL Square Tegular 	12" x 48"	8377PB	3290			6484W1_ _ _	6484W2_ _ _	6643M1_ _ _	6643M15_ _ _	
		12" x 60"							8225M1_ _ _	8225M15_ _ _	
		20" x 54"		3276†							
		20" x 56"		3266†							
		20" x 60"		3277†							
		21" x 24"		3279†							
	Silhouette® XL Square Tegular 1/4" Reveal 	24" x 24"	8361PB	3251†	2824		5406W1_ _ _	5406W2_ _ _	6641M1_ _ _	6641M15_ _ _	
		24" x 42"		3280†			6510W1_ _ _	6510W2_ _ _	6644M1_ _ _	6644M15_ _ _	
		24" x 48"	8357PB	3257†	2825		6486W1_ _ _	6486W2_ _ _	6642M1_ _ _	6642M15_ _ _	
		24" x 60"	8365PB	3265†					8226M1_ _ _	8226M15_ _ _	
		24" x 72"	8381PB	3261†					8227M1_ _ _	8227M15_ _ _	
		24" x 96"	8382PB	3262†							
		27" x 30"		3283†			6512W1_ _ _	6512W2_ _ _	6645M1_ _ _	6645M15_ _ _	
		28" x 30"	8461PB	3268†					8228M1_ _ _	8228M15_ _ _	
		28" x 60"		3269†					8229M1_ _ _	8229M15_ _ _	
		30" x 30"	8359PB	3259†			6511W1_ _ _	6511W2_ _ _	6646M1_ _ _	6646M15_ _ _	
	Interlude® XL HRC Square Tegular 	30" x 54"		3284†							
		30" x 56"	8466PB	3289†							
		30" x 60"	8385PB	3285†							
		42" x 48"	8462PB	3287†							
		44" x 48"	8463PB	3288†							
		48" x 48"	8356PB	3256†							
48" x 54"			3249†								
9/16"		Suprafine XL Beveled Tegular 	24" x 24"				1912† + Create!				
			24" x 48"				1915†				
			24" x 60"				1986†				
	24" x 72"					1982†					
	30" x 30"					1905†					
	30" x 54"					1929					
15/16"	Vector® with 1/4" Reveal 	24" x 24"		3900							
		24" x 48"		3908							
		24" x 72"		3906							
		24" x 96"		3907							
		30" x 30"		3904							
		48" x 48"		3909							

\_ \_ \_ = Color Suffix: WoodWorks Field & Technical Panel Color Choices: Beech (NBE), Maple (NMP), Light Cherry (NLC), Dark Cherry (NDC);

MetalWorks Field & Technical Panel Color Choices: Whitelume (WHA), Silverlume (SIA), Gun Metal (MYA), Black (BL)

\*\* These panels are 3/4" thick

† Environmental Product Declaration 

# FIELD PANELS

## PERFORMANCE SECTION

Description	NRC	Acoustics		Light Reflect	Sag Resistance	Recycling Program	Recycled Content
		CAC	AC				
Lyra® PB	0.95	N/A	190	0.88	HumiGuard +	Yes	71%
Optima® 1" thick panels	0.95	N/A	190	0.90	HumiGuard +	Yes	71%
Optima® 3/4" thick panels	0.90	N/A	180	0.90	HumiGuard +	Yes	71%
Optima® Vector® 7/8" thick panels	N/A	N/A	N/A	0.90	HumiGuard +	Yes	71%
Calla®	0.85	35	170	0.86	HumiGuard +	Yes	76%
Ultima®	0.75	35	N/A	0.90	HumiGuard +	Yes	Up to 80%
Ultima (items 1905, 1929)	0.75	35	N/A	0.90	Standard	Yes	Up to 80%
WoodWorks® Unperforated	N/A	38	N/A	N/A	N/A	No	Up to 63%**
WoodWorks W2 Perforated Acoustics with infill panel	0.40	28	N/A	N/A	N/A	No	Up to 63%**
MetalWorks™ Unperforated	0.40	28	N/A	0.89	N/A	No	25%
MetalWorks M15 Perforated	0.70	38†	N/A	0.77*	N/A	No	25%
MetalWorks M15 Perforated with additional fiberglass infill	0.90	N/A	N/A	0.77*	N/A	No	25%**

† With Item #747 mineral fiber backing  
 \* Value for White finish  
 \*\* Recycled content values do not include infill panels

## ACOUSTICAL CONSIDERATIONS

### Why Choose Mineral Fiber?

Mineral fiber ceiling panels provide excellent sound absorption and prevent sound transmission from one area to another; ideally suited for closed plan spaces.

### Why Choose Fiberglass?

Fiberglass panels offer high outstanding acoustical performance in open plan areas where noise levels and speech privacy are important. They also offer options of larger format ceiling panels.

## ALL LYRA PB, OPTIMA, CALLA, ULTIMA, AND METALWORKS PANELS ARE:



Class A Fire Rated



Anti-microbial



Washable



Scrubable



Impact-resistant

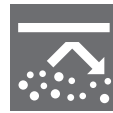

Soil-resistant



Light Reflect



Sag-resistant



Scratch-resistant

## CHOOSE YOUR TECHNICAL PANELS

### LYRA® PB



White\*  
(WH)

### WOODWORKS®

Natural Variations™  
(Real Wood Veneers)



Beech  
(NBE)



Maple  
(NMP)



Light Cherry  
(NLC)



Dark Cherry  
(NDC)

### Perforation options:



W1  
(Unperforated)

### OPTIMA®, ULTIMA®



White  
(WH)

### METALWORKS™



Whitelume\*  
(WHA)



Silverlume\*  
(SIA)



Gun Metal\*  
(MYA)







Black  
(BL)

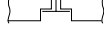

M1  
(Unperforated)

\*Part of the Sustain™ portfolio, and meets the most stringent industry sustainability compliance standards

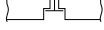
## ITEM NUMBERS AT-A-GLANCE

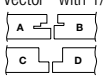
Suspension Dimension	Edge Profile	Dimensions	Lyra® PB	Optima®	Ultima®	WoodWorks® Unperforated	MetalWorks™ Unperforated
			Item Numbers				
15/16"	 Prelude® XL Square Lay-In	4" x 48"	8334PB	1462			7261M1WHA
		4" x 60"	8335PB	1463			7262M1WHA
		6" x 48"	8336PB	1400†	1420		7255M1___*
		6" x 60"	8337PB	1404†	1425		7256M1___*
15/16"	 Prelude XL Square Tegular	4" x 48"					7259M1WHA
		4" x 60"					7260M1WHA
		6" x 48"			1402†		
		6" x 60"			1406†		
		12" x 24"			3264		
15/16"	 Prelude XL Beveled Tegular	6" x 48"			1422		
		12" x 24"			1917†		
9/16"	 Suprafine® XL Square Tegular	4" x 48"	8344PB	1410			7251M1WHA
		4" x 60"	8345PB	1411			7252M1WHA
		6" x 12"		1413†			6648M1___*
		6" x 42"		1415†			
		6" x 48"	8346PB	1403†		6513W1___*	6649M1___*
		6" x 54"		1417†			
		6" x 60"	8347PB	1407†		6514W1___*	6650M1___*
		6" x 96"		1409†			
		12" x 24"		3263			
		12" x 48"		3290			
		12" x 60"					8225M1___*
		12" x 96"			1414†		
9/16"	 Suprafine XL Beveled Tegular	6" x 48"			1423		
		6" x 60"			1427		
		12" x 24"			1916†		
15/16"	 Vector® with 1/4" Reveal	6" x 48"		1466			7257M1WHA
		6" x 60"					7258M1WHA
		6" x 96"		1467			

\_\_\_ = Color Suffix: WoodWorks Field & Technical Panel Color Choices: Beech (NBE), Maple (NMP), Light Cherry (NLC), Dark Cherry (NDC); MetalWorks Field & Technical Panel Color Choices: Whitelume (WHA), Silverlume (SIA), Gun Metal (MYA)

† Environmental Product Declaration 



**Lyra PB**  
Square Tegular



**Ultima, Optima**  
Square Lay-in



**Ultima**  
Beveled Tegular



**Optima**  
Square Tegular



**Optima**  
Vector®



**MetalWorks Unperforated**  
Square Tegular



**MetalWorks**  
Unperforated Vector



**MetalWorks**  
Square Tegular



**WoodWorks**  
Square Tegular

# SUSPENSION SYSTEMS

## CHOOSE YOUR SUSPENSION SYSTEM

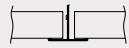

PRELUDE®  
15/16" Square Lay-in



PRELUDE  
15/16" Beveled Tegal



PRELUDE  
15/16" Square Tegal

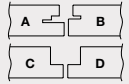

VECTOR®  
15/16" with 1/4" Reveal

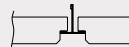

SUPRAFINE® XL®  
9/16" Beveled Tegal

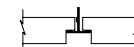
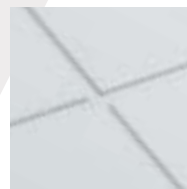

SUPRAFINE XL  
9/16" Square Tegal

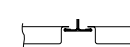

SUPRAFINE XL  
9/16" Metal  
Square Tegal

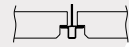

INTERLUDE® XL HRC  
9/16" Beveled Tegal

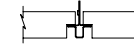
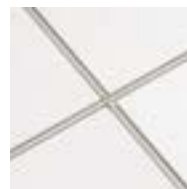

INTERLUDE XL HRC  
9/16" Square Tegal

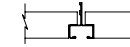

SILHOUETTE® XL  
9/16" Square Tegal  
(1/4" reveal)



TechZone® Ceiling System with Optima® Item 3160 48" x 48" Field Panels, and Optima Item 1403 6" x 48" Technical Panels, with Suprafine XL suspension system



## ITEM NUMBERS AT-A-GLANCE

### Item No. Description

#### Prelude® XL® - 15/16" Suspension System

7300	144" ID Prelude XL Main Beam
7301	144" HD Prelude XL Main Beam
7306	132" HD Prelude XL Main Beam
XL7304	4" Prelude XL Cross Tee
XL7306	6" Prelude XL Cross Tee
XL7328	24" Prelude XL Cross Tee
XL7340	48" Prelude XL ID Cross Tee
XL7341	48" Prelude XL HD Cross Tee
XL7358	60" Prelude XL Cross Tee
XL7378	30" Prelude XL Cross Tee
XL7380	96" Prelude XL Cross Tee
XL7390	72" Prelude XL Cross Tee

#### Suprafine® XL - 9/16" Suspension System

7500	144" ID Suprafine XL Main Beam
7501	144" HD Suprafine XL Main Beam
7504	120" HD Suprafine XL Main Beam
7505	100" HD Suprafine XL Main Beam
7507	144" HD Suprafine XL Main Beam
7508	132" HD Suprafine XL Main Beam
7512	120" HD Suprafine XL Main Beam
7588	88" Suprafine XL HD Main Beam
XL7504	4" Suprafine XL Cross Tee
XL7506	6" Suprafine XL Cross Tee
XL7510	12" Suprafine XL Cross Tee
XL7561	21" Suprafine XL Cross Tee
XL7520	24" Suprafine XL Cross Tee
XL7567	27" Suprafine XL Cross Tee
XL7528	28" Suprafine XL Cross Tee
XL7570	30" Suprafine XL Cross Tee
XL7562	42" Suprafine XL Cross Tee
XL7563	44" Suprafine XL Cross Tee
XL7540	48" Suprafine XL ID Cross Tee
XL7549	48" Suprafine XL HD Cross Tee
XL7564	54" Suprafine XL Cross Tee
XL7569	54" Suprafine XL Cross Tee
XL7556	56" Suprafine XL Cross Tee
XL7558	60" Suprafine XL Cross Tee
XL7568	66" Suprafine XL Cross Tee
XL7590	72" Suprafine XL Cross Tee
XL7580	96" Suprafine XL Cross Tee

#### Suprafine XL - Colors - 9/16" Suspension System

TZ7501xx	120" HD Suprafine Main Beam
TZ7504xx	144" HD Suprafine Main Beam, Routs 6" OC
TZXL7504xx	4" Suprafine XL Cross Tee
TZXL7506xx	6" Suprafine XL Cross Tee
TZXL7510xx	12" Suprafine XL Cross Tee
TZXL7520xx	24" Suprafine XL Cross Tee
TZXL7567xx	27" Suprafine XL Cross Tee
TZXL7570xx	30" Suprafine XL Cross Tee
TZXL7562xx	42" Suprafine XL Cross Tee
TZXL7541xx	48" Suprafine XL Cross Tee
TZXL7564xx	54" Suprafine XL Cross Tee
TZXL7556xx	56" Suprafine XL Cross Tee
TZXL7558xx	60" Suprafine XL Cross Tee
TZXL7568xx	66" Suprafine XL Cross Tee

### Item No. Description

#### Interlude® XL HRC - 9/16" Suspension System

6100HRC	144" ID Interlude XL HRC Main Beam
6101HRC	144" HD Interlude XL HRC Main Beam
6121HRC	144" ID Interlude XL HRC Main Beam
6121AHRC	144" HD Interlude XL HRC Main Beam
6122HRC	120" HD Interlude XL HRC Main Beam
6123HRC	88" HD Interlude XL HRC Main Beam
6127HRC	120" HD Interlude XL HRC Main Beam
6132HRC	132" HD Interlude XL HRC Main Beam
6187HRC	100" HD Interlude XL HRC Main Beam
XL6104HRC	4" Interlude XL HRC Cross Tee
XL6106HRC	6" Interlude XL HRC Cross Tee
XL6110HRC	12" Interlude XL HRC Cross Tee
XL6161HRC	21" Interlude XL HRC Cross Tee
XL6120HRC	24" Interlude XL HRC Cross Tee
XL6167HRC	27" Interlude XL HRC Cross Tee
XL6128HRC	28" Interlude XL HRC Cross Tee
XL6170HRC	30" Interlude XL HRC Cross Tee
XL6162HRC	42" Interlude XL HRC Cross Tee
XL6163HRC	44" Interlude XL HRC Cross Tee
XL6140HRC	48" Interlude XL HRC Cross Tee
XL6164AHRC	54" Interlude XL HRC Cross Tee
XL6169HRC	54" Interlude XL HRC Cross Tee
XL6156HRC	56" Interlude XL HRC Cross Tee
XL6150HRC	60" Interlude XL HRC Cross Tee
XL6168HRC	66" Interlude XL HRC Cross Tee
XL6190HRC	72" Interlude XL HRC Cross Tee
XL6180HRC	96" Interlude XL HRC Cross Tee

#### Silhouette® XL 1/4" Reveal - 9/16" Suspension System

7609	12' Silhouette Main Beam, Routs 21", 27", 69", 75", 117", 123"
7611	144" HD Silhouette XL Main Beam
7613	108" HD Silhouette XL Main Beam
7616	78" Silhouette HD Main Beam, Routs 12", 36", 60", 66"
7619	78" Silhouette XL Main Beam
7621	132" HD Silhouette XL Main Beam
7622	102" HD Silhouette XL Main Beam
7625	102" Silhouette HD Main Beam, Routs 24", 72", 78"
7627	120" Silhouette HD Main Beam, Routs 13.5", 40.5", 46.5", 73.5", 100.5", 106.5"
7629	132" Silhouette Main Beam, Routs 30", 36", 96", 102"
7637	96" HD Silhouette XL Main Beam
7638	126" HD Silhouette XL Main Beam
7639	126" HD Silhouette XL Main Beam
XL7604	4" Silhouette XL Cross Tee
XL7606	6" Silhouette XL Cross Tee
XL7621	21" Silhouette XL Cross Tee
XL7620	27" Silhouette XL Cross Tee
XL7670	30" Silhouette XL Cross Tee
XL7662	42" Silhouette XL Cross Tee
XL7663	44" Silhouette XL Cross Tee
XL7640	48" Silhouette XL Cross Tee
XL7645	48" Silhouette XL Cross Tee - center notched both sides
XL7646	48" Silhouette XL Cross Tee - center notched one side
XL7652	54" Silhouette XL Cross Tee
XL7653	56" Silhouette XL Cross Tee
XL7651	60" Silhouette XL Cross Tee - notched one side at 20" and 40"
XL7654	60" Silhouette XL Cross Tee - notched both sides at 20" and 40"
XL7655	60" Silhouette XL Cross Tee - center notched both sides
XL7656	60" Silhouette XL Cross Tee - center notched one side
XL7690	72" Silhouette XL Cross Tee
XL7680	96" Silhouette XL Cross Tee
XL7627A	27" Silhouette Unnotched XL
XL7642	42" Silhouette Unnotched XL

# PERIMETER TREATMENT

## CHOOSE YOUR PERIMETER TREATMENT

- A. Wall-to-wall installations
- B. Cloud/Floating installations
- C. Elevation or material transitions in the ceiling plane

### Accessories

Item No.	Description
TZYK	TechZone® Yoke (2 yokes required per assembly)
TZBC	TechZone Bracing Clip
STAC	Single Tee Attachment Clip
XTAC	Cross Tee Attachment Clip
AXTBC	Axiom® T-Bar Connector Clip
7891	12 Gauge Hanger Wire

## A. SELECT PERIMETER ANGLE AT WALL

Tegular, Lay-in, and Vector® Shadow Molding

- 7875 – A-3/4", B-15/16", C-1/2"
- 7877 – A-15/16", B-15/16", C-1/4"
- 7897 – A-15/16", B-15/16", C-1/2"

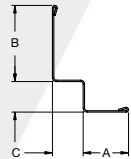

Tegular, Lay-in, and Vector Angle Molding

- 7800 – A-7/8", B-7/8"
- 7804 – A-9/16", B-7/8"
- 7808 – A-2", B-2"

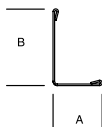

Axiom® Classic Trim – straight or curved

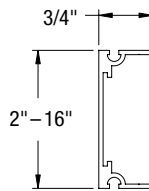

Axiom Vector Trim – straight or curved

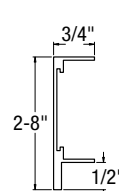

WoodWorks® Trim (with aluminum substrate) – straight or curved

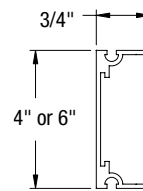

## C. SELECT TRANSITION COMPONENTS

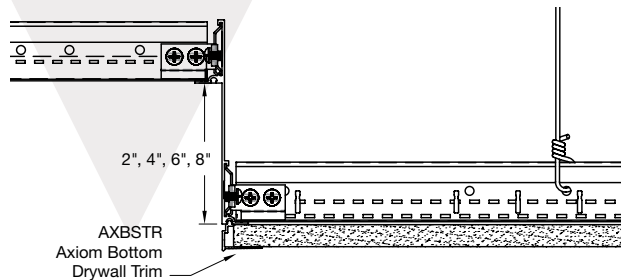

Axiom Transitions  
Acoustical Ceiling to Drywall Elevation Changes

- Curved AXTRXCUR
- Straight AXTRXSTR

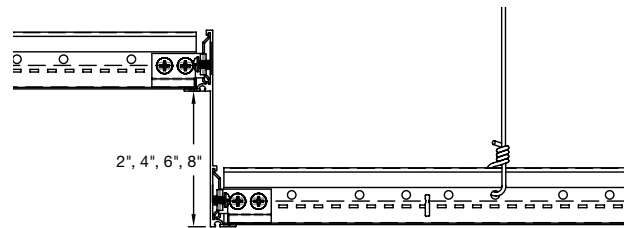

Axiom Transitions  
Acoustical Ceiling to Acoustical Ceiling Elevation Changes

- Curved AXTRXCUR
- Straight AXTRXSTR

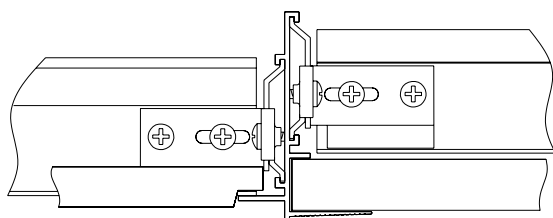

Axiom Transitions  
Acoustical Ceiling to Drywall in Same Plane

- Curved AXTRTECUR
- Straight AXTRTESTR

Specify technical fixtures with confidence. We've made it easy by teaming with industry leaders in lighting, air diffusers, fire protection, chilled beams, and sound masking to assure fit and finish. Select from a variety of linear LED fixtures in continuous and discontinuous layouts. Look for Armstrong® "TechZone-compatible" on partner websites and literature.

### Lighting

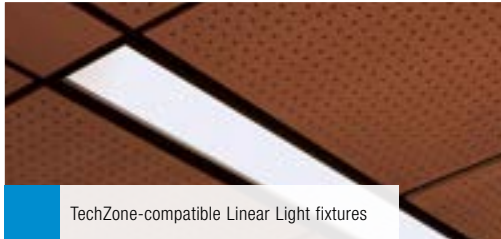

### Heating and Cooling



### Diffusers

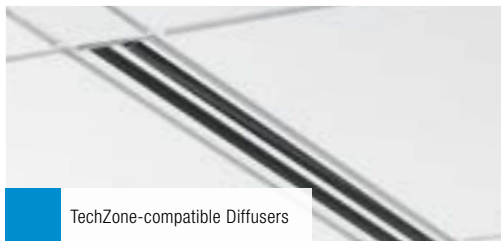

### Sprinkler Connections



Product Matrix	Vector® Fixtures 6" Linear	Square Lay-in and Regular Fixtures 6" Continuous	Square Lay-in and Regular Fixtures 6" Linear	Square Lay-in and Regular Fixtures 4" Continuous	Square Lay-in and Regular Fixtures 4" Linear	Chilled Beams	Diffusers	Sprinklers	4" BeveLED® CONNECT™ Downlight
<b>FLEXHEAD</b>								•	
<b>FOCAL POINT</b>	•	•	•	•					
<b>PRICE</b>						•	•		
<b>USAI Lighting</b>									•
<b>axis</b>	•	•	•	•					
<b>XAL</b>				•	•				

# ACCESSORIES

## TECHZONE® YOKE ALLOWS FOR TRUE CONTINUOUS LIGHT CONFIGURATION

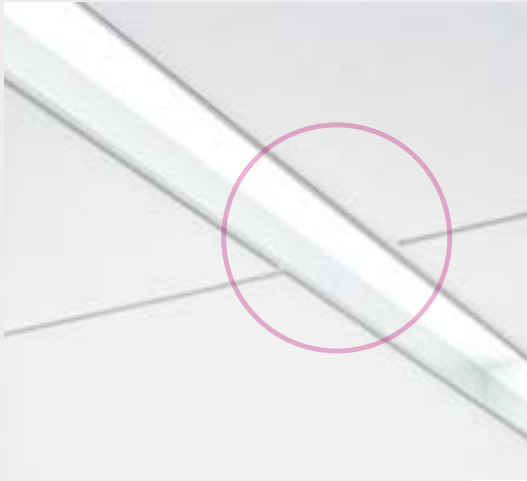

Continuous lighting

- Create a sleek ceiling design with uninterrupted ribbons of light
- Alternate continuous lights and diffusers with other services for a monolithic, uncluttered visual
- Easy installation
- Seismic tested
- Ability to use with 4" and 6" configurations

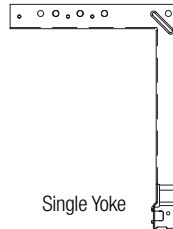

Single Yoke

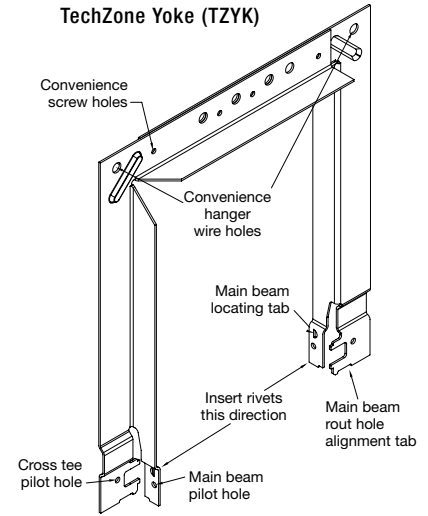

(2 yokes required per assembly)

## CLIPS

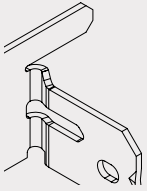

### STAC Clip

Create a playful design with off module lighting. Seismic tested.

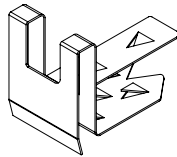

### Stabilizer Clip, Item 435, for Optima®

Recommended for panels 5' and greater in length. Ordered separately.

NOTE:  
Panels 5' up to 8' – One clip installed near the midpoint of each long edge.  
Panels 8' – Two clips installed at one-third points of each long edge.

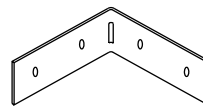

### Cross Tee Adapter Clip (XTAC)

Used to attach field-cut cross tees to main beams.

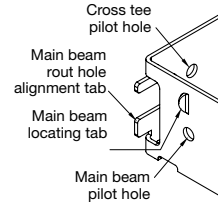

### TechZone Bracing Clip (TZBC)

Use to connect cross tees to the main beam of the continuous technical zone when no yoke is present.

## VECTOR® ACCESSORIES

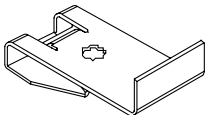

### Vector Border Clip

Required for installations with the suspension system resting on the wall molding. Primarily used for corners and special cutouts.

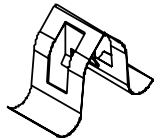

### Vector Hold Down Clip

Required for installation.

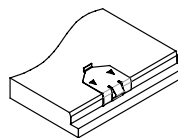

### Mid-point Clip

For 48" x 48" Vector panels only.

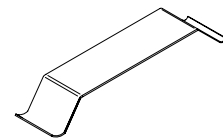

### Spring Border Clip

For installations with the panel resting on the wall molding.

# SYSTEM LAYOUT AND COMPONENTS

## 4" WIDE TECHNICAL ZONE CONFIGURATION – OPTIMA® AND LYRA® PB ONLY

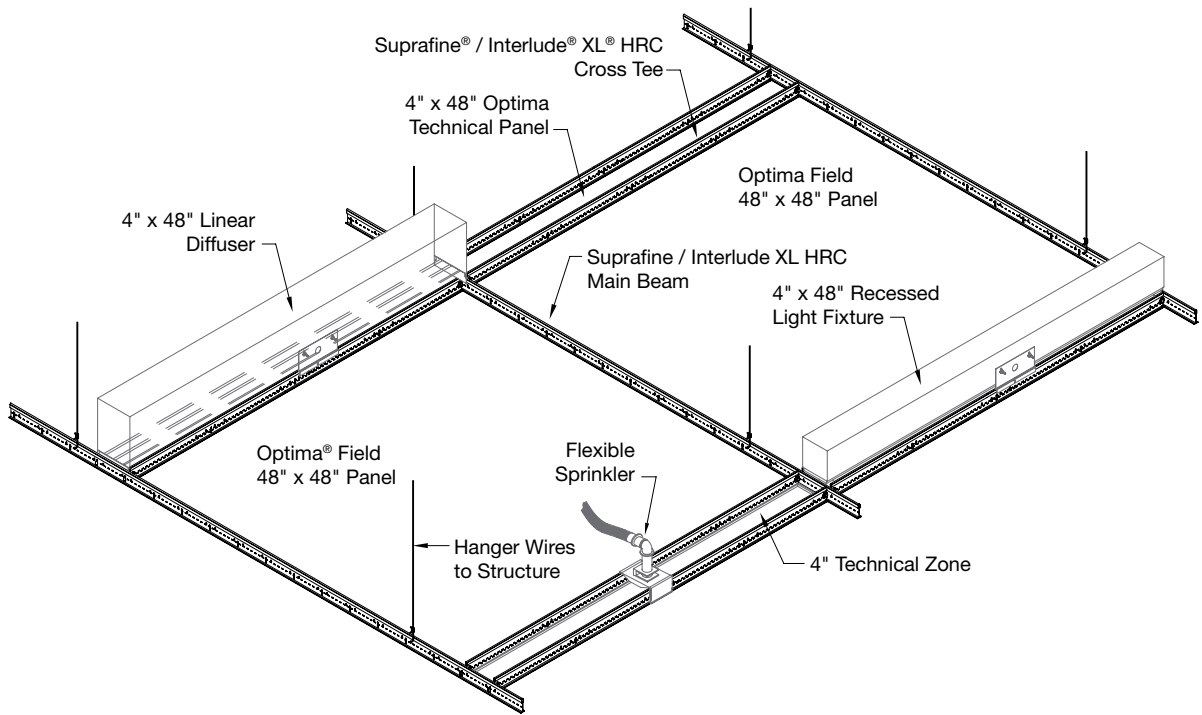

## 6" WIDE TECHNICAL ZONE CONFIGURATION

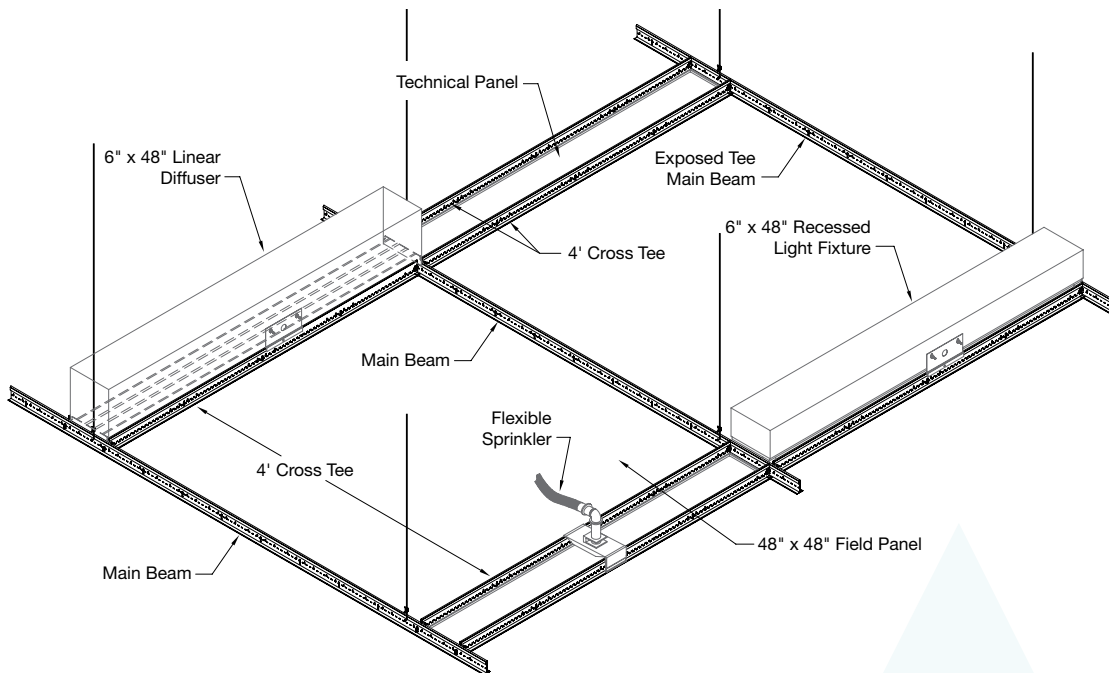

# SYSTEM LAYOUT AND COMPONENTS

## 4" WIDE TECHNICAL ZONE CONFIGURATION FOR CONTINUOUS LIGHTING FIXTURES

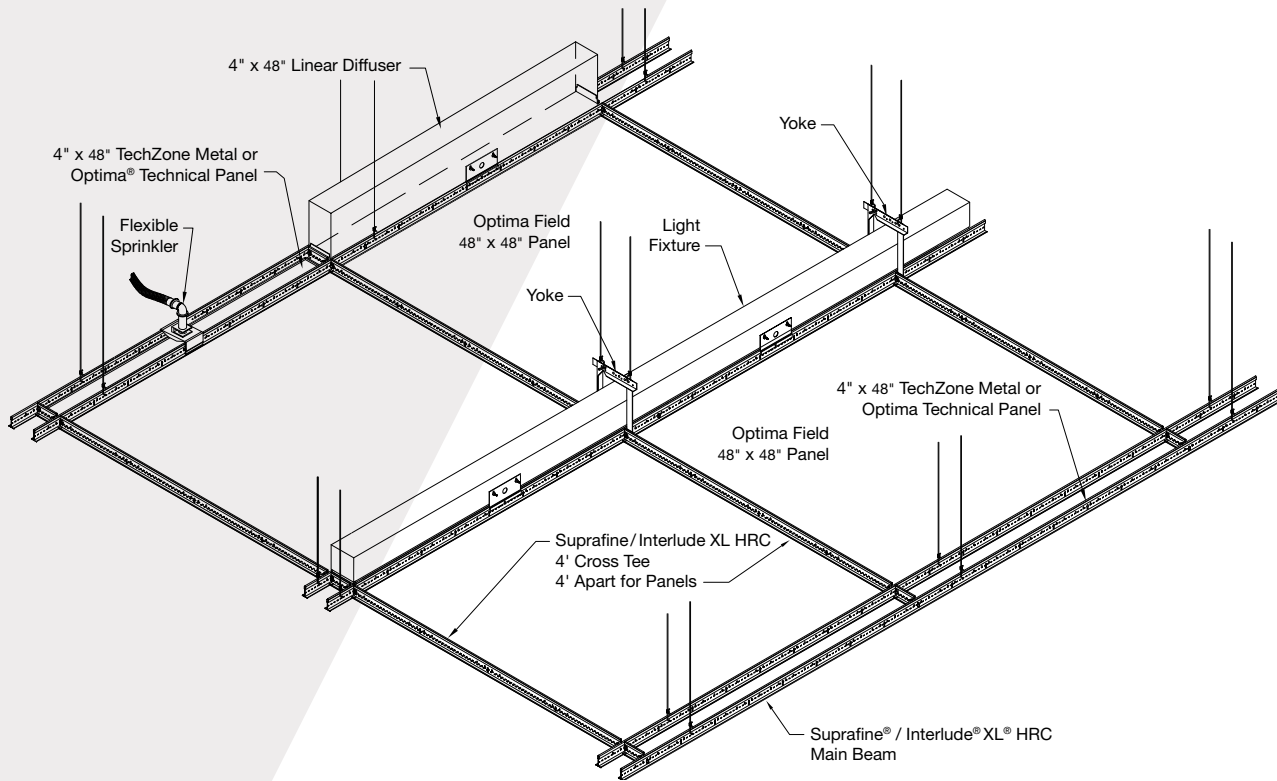

## 6" WIDE TECHNICAL ZONE CONFIGURATION FOR CONTINUOUS LIGHTING FIXTURES

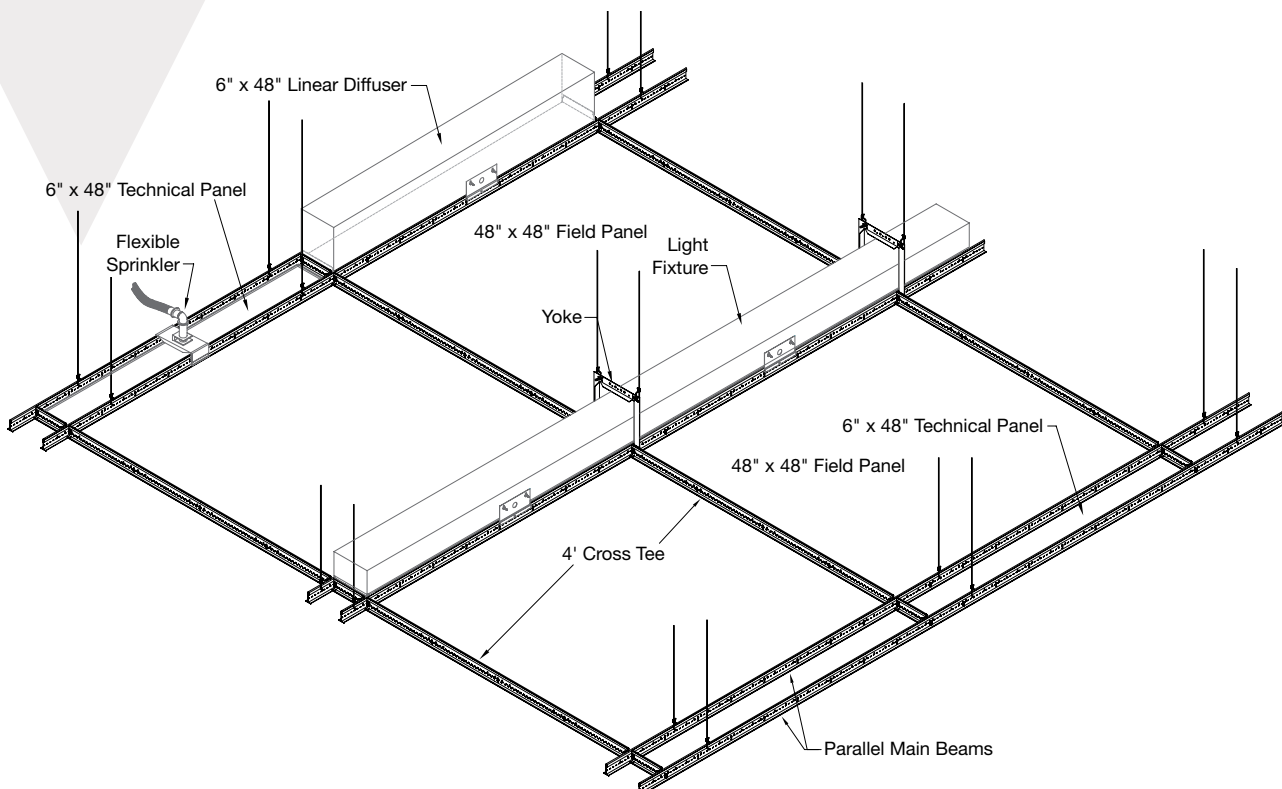

# SYSTEM LAYOUT AND COMPONENTS

## 6" WIDE TECHNICAL ZONE CONFIGURATION FOR WOODWORKS®

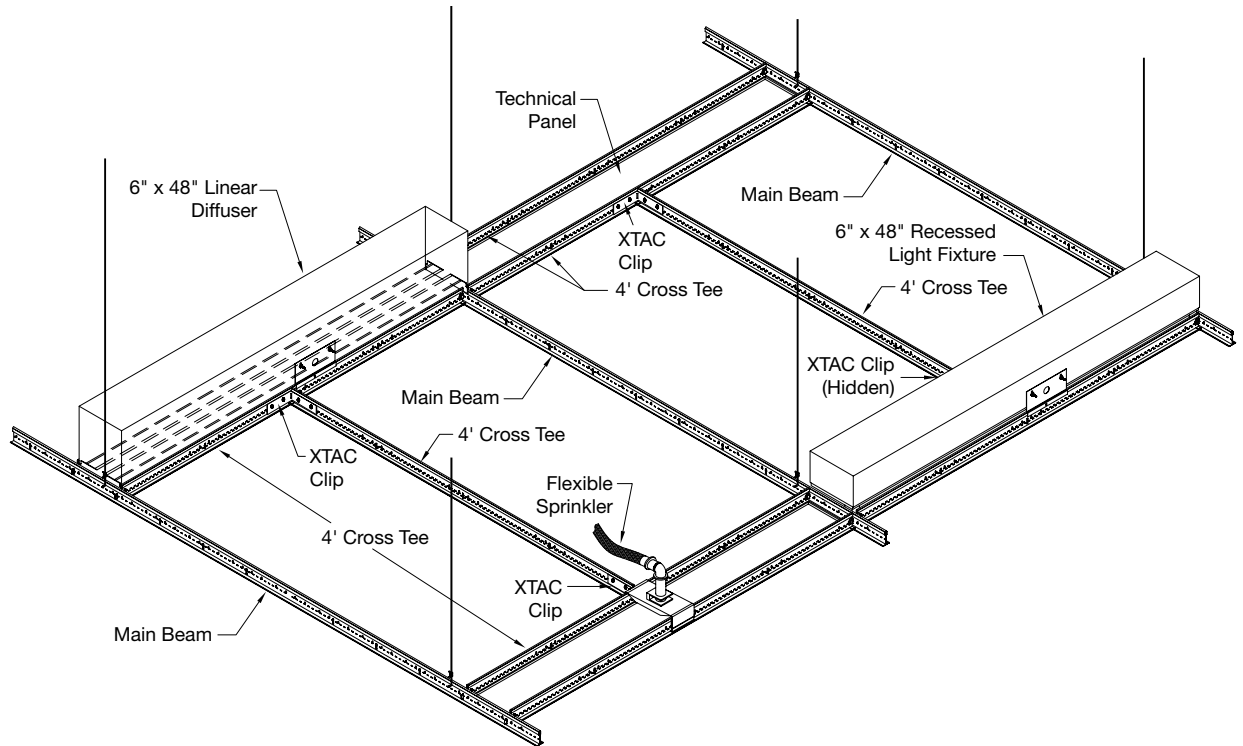

## TECHNICAL ZONE OPENING DIMENSIONS

4" Technical Zone

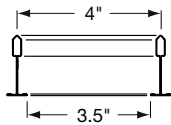

Cross Section – Suprafine

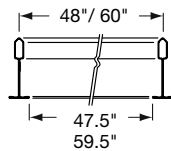

Cross Section – Suprafine

6" Technical Zone

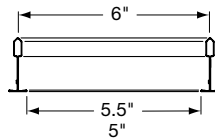

9/16" or 15/16" Suspension System

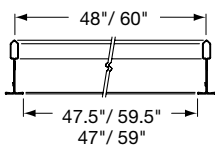

9/16" or 15/16" Suspension System

12" Technical Zone

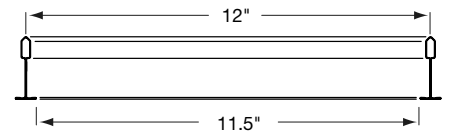

Cross Section – Suprafine

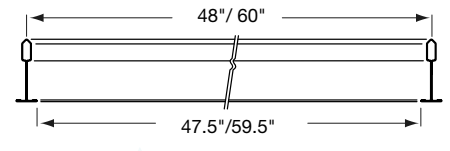

Cross Section – Suprafine

**877 276-7876**

Customer Service Representatives  
7:45 a.m. to 5:00 p.m. EST  
Monday through Friday

**TechLine** – Technical information, detail drawings, CAD design assistance, installation information, other technical services – 8:00 a.m. to 5:30 p.m. EST, Monday through Friday. FAX 1 800 572 8324 or email: [techline@armstrongceilings.com](mailto:techline@armstrongceilings.com)

**[armstrongceilings.com/commercial](http://armstrongceilings.com/commercial)**

Latest product news  
Standard and custom product information  
Online catalog  
CAD, Revit®, SketchUp® files  
A Ceiling for Every Space® Visual Selection Tool  
Product literature and samples – express service or regular delivery  
Contacts – reps, where to buy, who will install



**[armstrongceilings.com/projectworks](http://armstrongceilings.com/projectworks)**

The power of **ProjectWorks**® Design and Pre-Construction Service

Mix and match different sizes, shapes, colors, and materials to reinvent your standard, specialty, or custom ceiling.

Visit our pattern gallery online to see ideas for your next project at [armstrongceilings.com/patterngallery](http://armstrongceilings.com/patterngallery)

Contact your local representative to get a design started! Not sure who your local rep is? Visit [armstrongceilings.com/findarep](http://armstrongceilings.com/findarep)

FSC® is a registered trademark of Forest Stewardship Council®, A.C., license code FSC-C007626;  
SketchUp® is a registered trademark of Trimble Inc.; Revit® is a registered trademark of Autodesk, Inc.;  
Lutron® is a registered trademark of Lutron Electronics Co., Inc.;  
All other trademarks used herein are the property of AWI Licensing LLC and/or its affiliates  
© 2023 AWI Licensing LLC • Printed in the United States of America

**TechLine / 1 877 276-7876**  
**[armstrongceilings.com/techzone](http://armstrongceilings.com/techzone)**

