

MODULAR CEILING SOLUTIONS



OVERCAST[®]
INNOVATIONS

CATALOG / 2024



Table of Contents

Who is Overcast Innovations?

4

Modular Grid Platform

8

The Cloud

13

Cloud Models

16

Finish Options

18

Lighting Options

24

Cloud Technology Configuration Options

32

Cloud Accessories

36

Certifications and Warranty

41

WE ARE THE FUTURE OF INTEGRATED BUILDING SOLUTIONS

Overcast Innovations rose from a need to make buildings more intelligent, sustainable and affordable. We are compelled by our vision, mission and values to meet that challenge head on. We think big, challenge broken systems and build trusted partnerships to deliver more value to our clients and the communities we collectively serve.

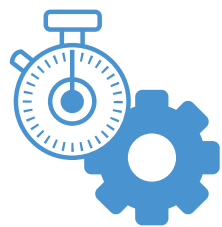

**Drive Out
Inefficiency & Waste**

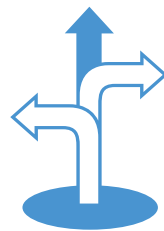

**Build Lifelong
Flexibility**



**Reduce Costs,
Time & Frustration**

We Think Big

We are problem solvers that refuse to back down from a challenge. Our built environment is too expensive, inefficient and outdated. That fact drives us to innovate the waste and climate harm out of the built environment.

The status quo is not enough. We challenge what's possible in our drive to solve the affordability crisis that plagues our built environment. Fresh thinking creates new opportunities to streamline process, costs and timelines through innovative design and manufacturing approaches.

**We Challenge
What's
Possible**

**We Build
Trusted
Partnerships**

You deserve more than just another product vendor. Partnerships are our passion. From design to manufacturing to installation, Overcast Innovations integrates seamlessly within your project teams to bring your vision to life.

SUSTAINABILITY

At Overcast, sustainability is always in focus and extends from what we design and manufacture to how we run our internal business processes.

Our objective is to lessen the environmental impact of construction and renovation at every stage and deliver to owners a system on which they can base their own low-impact operations.

There are four key elements that highlight our sustainability efforts:

Declare Label



Materials matter. Therefore, Declare. Having received our Declare Label from the International Living Future Institute is but one of our initial steps to help contribute to a more sustainable future.

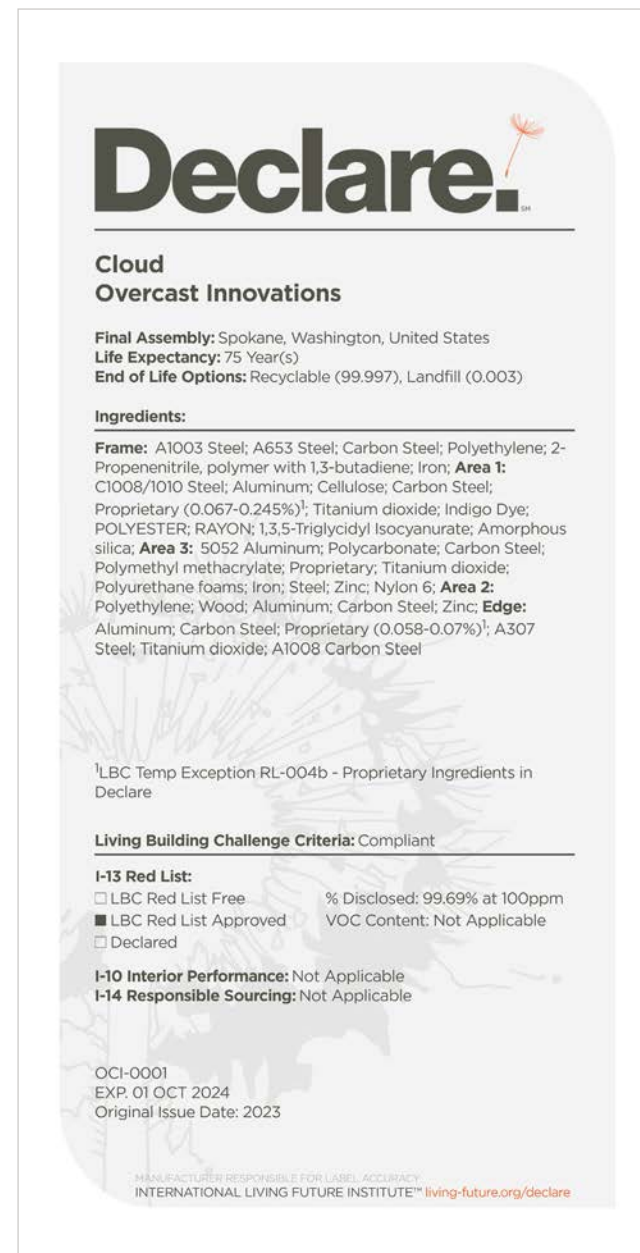

Supply Chain



Overcast believes that having great products is one thing but that having them manufactured locally is an even better thing. Every day we assess the impact we have on shipping traffic and emissions, therefore we rely on local and near-local suppliers to ensure the best quality at the lowest environmental impact.

Adaptive Reuse



Tenants change. Space programming changes. Overcast solutions are designed to morph with your changes. Upgrade the technology devices. Move the technology devices. Or, move the Overcast Cloud or Modular Grid Platform to another location and then upgrade or move the technology devices. The point is that you have options and none of them involve a landfill.

Decarbonization



Constructing generates about 50% of the carbon footprint of the building throughout its entire life cycle. Using Overcast cuts the time, fuel and electrical tool usage required to field-install building technology. The adaptive re-use continues the cycle of carbon reduction.



Modular Grid Platform

Our Modular Grid Platform (MGP) is designed to drive efficiency in the design, organization and installation process of the 15 or more building systems and technologies located in the ceiling plane. We employ an industrialized construction methodology and approach, manufacturing our MGP ceiling panels off-site and arriving on-site as a finished good, allowing for a more organized, expedited and efficient solution where the panels install quickly utilizing the ceiling grid as the carrier support. The MGP solution truly lights the way as a more streamlined, cost-effective and sustainable approach to building construction

With the Overcast MGP, you will:

- Streamline on-site trade coordination
- Drive construction schedule savings
- Contribute to decarbonization of the facility throughout its life cycle
- Maximize design options with many different platform configurations (including regular options)
- Enhance operations and maintenance post-construction
- Future-proof the facility by reconfiguring the panels as space needs change

The MGP works well with both new construction and renovations, is sustainably manufactured, is built to last the life of the building and installs in 15/16" and 9/16" grids.

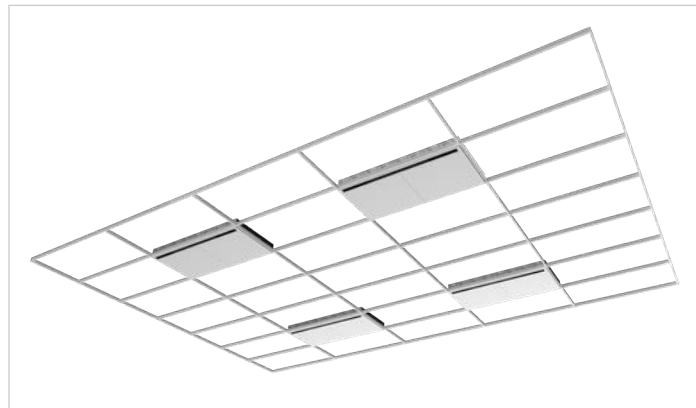

Scan for more information



Modular Grid Models

Size -- -	Lighting						Finish	
	Type -- -	Quantity & Location -- -						
2 2x2 Panels	2DL	2' Linear Louver	1	E	End	S__	Solid Metal	
4 2x4 Panel	4DL	4' Linear Louver	2	M	Middle	P__	Perforated Metal	
6 2x6 Panel	6DL	6' Linear Louver		L	Left		Note: See 'Finish Options' table on page 17 for color options to complete this section.	
	3DNR	3" Downlight Round		R	Right			
	1DSF__	1" Downlight F1 = Fixed 1 Light F2 = Fixed 2 Light F3 = Fixed 3 Light F5 = Fixed 5 Light F10 = Fixed 10 Light						
	XX	Not Applicable						

Technology Options
Sensors OC1 - Leviton, Lighting Occupancy OC2 - Creston, Occupancy OC3 - NLight, Small Motion Occupancy OC4 - NLight, Large Motion Occupancy MS__ - Distech, Multi-Sensor Series DS1 - Leviton, Daylight AQ - Awair, Air Quality
Fire Alarm FAS0 - Speaker Only FASS - Speaker Strobe
Fire Sprinkler FS - Fire Sprinkler
Wireless Access & Sound AM - Sound Masking WIFI1 - WiFi, Aruba WIFI2 - WiFi, Ubiquiti WIFI3 - WiFi, Cisco AS - Audio Speaker ASH - Audio Speaker High-Bay CAM1 - Camera, Verkada
Diffusers & Return Grilles DP__ - Architectural Plaque Diffuser DM__ - Modular Core Air Diffuser RG__ - Return Grille
Other devices not listed can be integrated upon request

Configuration Notes:

- See lighting specifications to learn more about the current luminaire options available on pages 24-31.
- Technology configurations are limitless and can be tailored to meet the space needs. The center of any panel can be specified to host one of any of the technology options listed on pages 32-35.

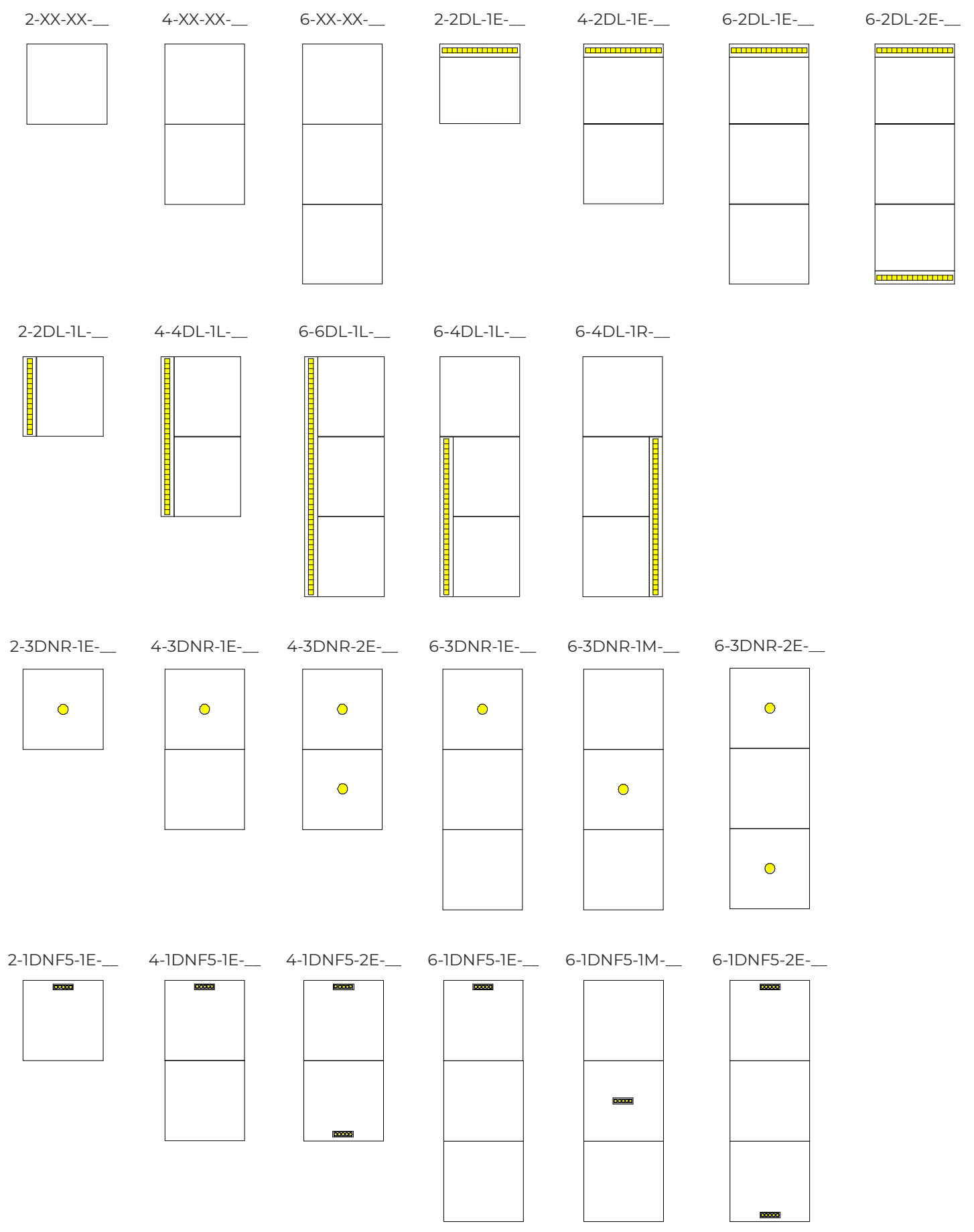
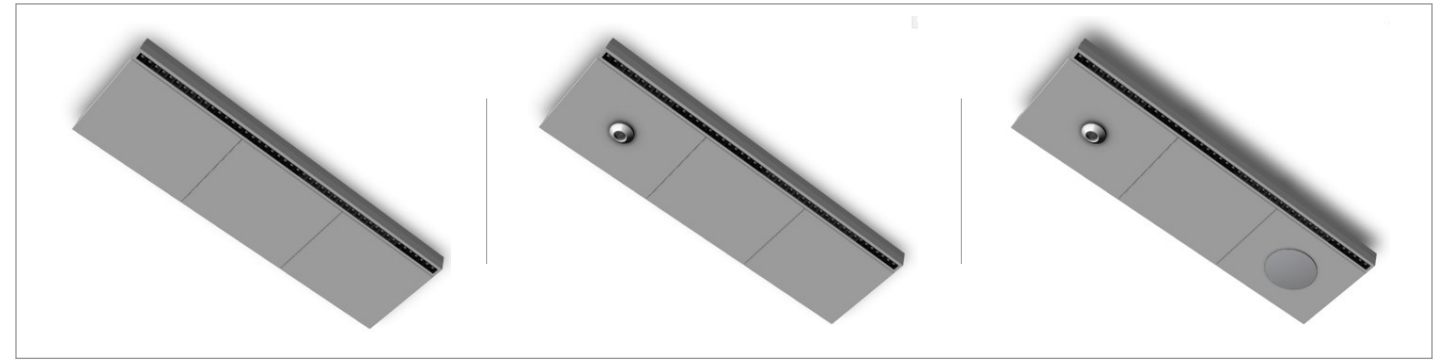
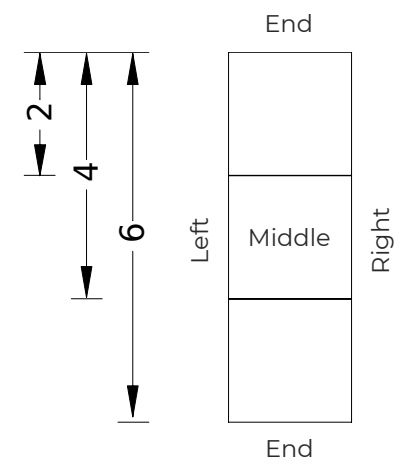



The Cloud was born for Open-to-Structure

Overcast Cloud add impressive acoustic performance to the Modular Grid Platform. Enhancing the sustainability of your mass timber structure while solving the inherent acoustical challenge in open-to-structure spaces, the Cloud is the best answer for organizing your ceiling aesthetically.

Smarter buildings through integrated, elegant and highly configurable ceiling assemblies:

- HVAC Equipment and Controls
- LED Lighting and Controls
- Acoustic Attenuation
- Smart Building Sensors and Controls
- Integrated AV and Data Connectivity
- Indoor Air Quality and Temperature Sensors
- Fire and Life Safety Systems

Key benefits of the Cloud include:

- Construction schedule time savings
- Fast and intuitive installation
- Reduced embodied carbon
- Future proof the building
- Increased safety by utilizing manufacturing methods instead of traditional building techniques
- Better collaboration through design



* U.S. Patent No. 11,487,307

Scan for more information



Designed For Every Space

Cloud systems are designed, manufactured and delivered to your specifications. We integrate into your project team to understand your vision and start with the end in mind. From there, we engineer and manufacture a product that connects a dozen or more building systems/ technologies into a plug-and-play ceiling assembly.

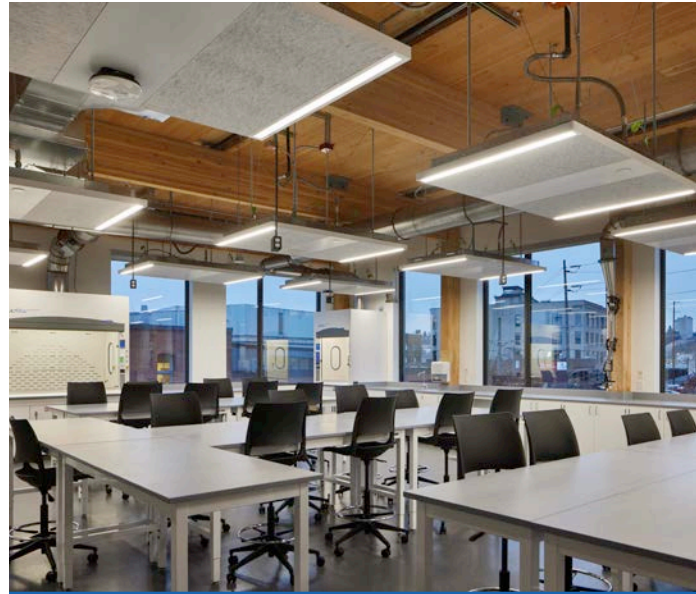

EDUCATION



HEALTHCARE



LIFE SCIENCES



OFFICE SPACE



Multiple sizing options to allow for a perfect fit for your space

Myriad finish options

Diverse lighting configurations

Trim design with 2" or 6" depths with standard and custom color options

Fully configurable technology lanes to meet your technology needs and wants

Cloud Models

The Cloud system allows you to pick exactly what works best for your facility and needs. Our system experts will help guide the design team through various Cloud models and configurations that align with your design intent.

The Overcast Cloud is configured in three simple steps:

- Step 1: Cloud Form (W x L x H)
- Step 2: Panel Configurations
- Step 3: Finish Selection

Step 2

Panel Configurations					
Area 1		Area 2		Area 3	
Lighting	Finish	Lighting	Finish	Lighting	Finish
3DNR.AxC 3" Downlight Round, Panel A & C	S__ Solid Metal	3DNR 3" Downlight Round	1PF__ 1" Polyester Felt	4DR 4' Direct Regress	S__ Solid Metal
3DNR.xBx 3" Downlight Round, Panel B Only	P__ Perforated Metal	XX Not Applicable	2PF__ 2" Polyester Felt	4DLI 4' Direct Louver with Indirect	Note: See 'Step 3' Finish Options by Material to complete this section
Note: Downlights are available in any panel combination. Two common options are documented above.		Note: See 'Step 3' Finish Options by Material to complete this section		6DR 6' Direct Regress	
XX Not Applicable			1FG__ 1" Fiberglass	6DLI 6' Direct Louver with Indirect	Note: See 'Step 3' Finish Options by Material to complete this section
			P__ Perforated Metal	Note: Linear light fixture lengths match the width (W) of the Cloud Size selected	
			4WD__ 4" Wood Slats		
			1DNF1 1" Downlight, Fixed 1 Light		
			1DNF2 1" Downlight, Fixed 2 Light		
			1DNF3 1" Downlight, Fixed 3 Light	1DNF5 1" Downlight, Fixed 5 Light	
			1DNF10 1" Downlight, Fixed 10 Light		
			XX Not Applicable		

LINEAR DIRECT REGRESS (DR)



LINEAR DIRECT LOUVER W/ INDIRECT (DLI) OR LINEAR DIRECT LOUVER (DL)



DOWNLIGHT 3" ROUND (3DNR) / 1" (1DNF)



Step 1

Cloud Form			
Size (W x L)	Area 1	Perimeter Trim	Height (H)
46 4'x6'	W3 26" with 3 Panels	2 2" Perimeter Trim	S__ Solid Metal
48 4'x8'		6 6" Perimeter Trim	Note: See 'Step 3' Finish Options by Material to complete this section
66 6'x6'			
Note: See lighting product data to match fixture height to perimeter trim.			

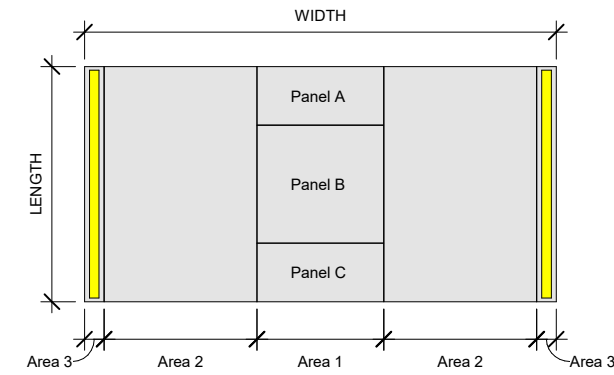

Example Cloud Model Number

Cloud Form	Area 1	Area 2	Area 3
48-W3-6-SWG	XX-PWG	XX-2PFLG	4DLI-SWG

46-W3-__ XX-__ XX-__ 4DLI-__	48-W3-__ XX-__ XX-__ 4DLI-__	66-W3-__ XX-__ XX-__ 4DLI-__
46-W3-__ XX-__ XX-__ 4DR-__	48-W3-__ XX-__ XX-__ 4DR-__	66-W3-__ XX-__ XX-__ 4DR-__
46-W3-__ XX-__ XX-__ 1DNF3-__	48-W3-__ XX-__ XX-__ 1DNF3-__	66-W3-__ XX-__ XX-__ 1DNF3-__
46-W3-__ XX-__ 3DNR-__ XX-__	48-W3-__ XX-__ 3DNR-__ XX-__	66-W3-__ XX-__ 3DNR-__ XX-__
46-W3-__ 3DNR.AxC-__ XX-__ XX-__	48-W3-__ 3DNR.AxC-__ XX-__ XX-__	66-W3-__ 3DNR.AxC-__ XX-__ XX-__
46-W3-__ 3DNR.xBx-__ XX-__ XX-__	48-W3-__ 3DNR.xBx-__ XX-__ XX-__	66-W3-__ 3DNR.xBx-__ XX-__ XX-__

Step 3

Finish Selection			
Material		Color Code	
P Perforated Metal		WG White Gloss	
S Solid Metal		WS White Satin	
		BS Black Satin	
		MG Metallic Gray	
		MS Metallic Anodized Silver	
1PF 1" Polyester Felt		WH White	
2PF 2" Polyester Felt		LG Light Gray	
		CH Charcoal / Dark Gray	
		BL Black	
1FG 1" Fiberglass		WH White	
4WD 4" Wood Slats		MAP Maple Stain	
		FIR Fir Stain	
		OAK Oak Stain	
		TEA Teak Stain	
		CHE Cherry Stain	
		MAH Mahogany Stain	
		DRI Driftwood Finish	
		WAL Walnut Stain	
		EBO Ebony Stain	
		BLA Black Opaque	
		WHI White Opaque	
		PIC Pickle Finish	

For Finish Selection details, see page 18

Metal Panels

Panel Examples:



SMOOTH



PERFORATED

Perforation:
Hole Diameter: 0.062"
Open Area: 22.5%

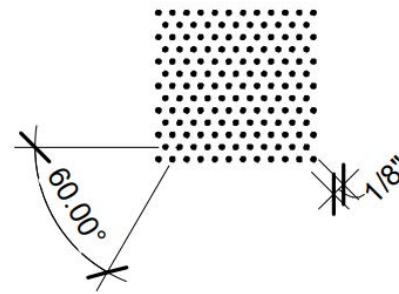

Key Features

- 20-gauge flat rolled steel, 0.0359"
- Recycled content, 36.9% to 89.9%
- Post-consumer recycled content: 19.8% to 69%
- Pre-consumer recycled content: 14.4% to 19.5%
- Panel sizes vary based on Cloud configuration
- Waste reduced with factory fabricated dimensional material
- Square edge design
- Panels include torsion springs that, when released, allow the panel to swing down to provide access above
- Acoustic option - 2" cotton sound blanket made from 100% post-consumer recycled denim
- Smooth or perforated surface options with powder-coat finish
- Class A per ASTM E84 fire rating
- Zones A, B, C, D, E, and F seismic rating
- No VOCs

Standard Powder Coat Colors

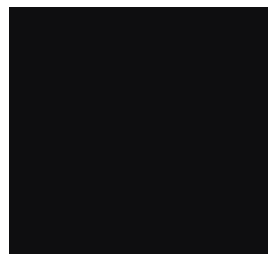

BLACK SATIN

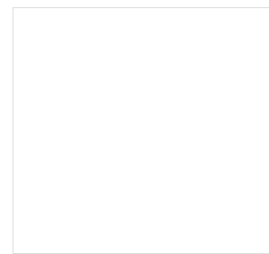

WHITE GLOSS

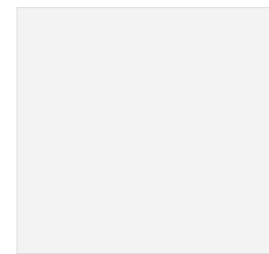

WHITE SATIN

Premium Metallic Powder Coat

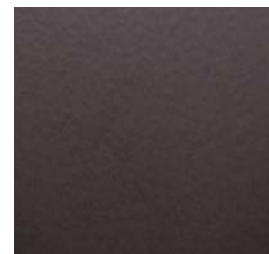

METALLIC GRAY



METALLIC SILVER

NOTE: Alternate powder coat colors are available upon request

Wood Slat Panels

The Overcast team has curated a wide palette of wood finish options that coordinate well with the other material options available in the Cloud product line. The wood slat panel system offers a design where the individual wood members are wider than they are deep. The wood members are backed with a 1/2" layer of black polyester felt insulation. The panel connects with a torsion spring assembly.

The wood slat system is designed to get a premium look on a tight budget. We have selected Western Hemlock as the basis for our product line because it is cost-effective, readily available, with a light wood color that accepts a wide variety of stains to achieve the desired look.



Key Features

- 1x4 PEFC Western Hemlock slats with clear, matte sheen finish applied over stain/finish selected
- Wood panels vary by size base on Cloud configuration
- Spacing between members varies between 5/8" and 3/4" depending on panel size; open area is between 17% and 20%
- Factory fabricated dimensional material to reduce waste
- Square edge design
- Panels include torsion springs that, when released, allow the panel to swing down to provide access above
- Wood members can be treated with Class 1 (A) fire retardant chemicals if required
- Zones A, B, C, D, E, and F seismic rating



MAPLE STAIN (MAP)

FIR STAIN (FIR)

OAK STAIN (OAK)

TEAK STAIN (TEA)

CHERRY STAIN (CHE)

MAHOGANY STAIN (MAH)

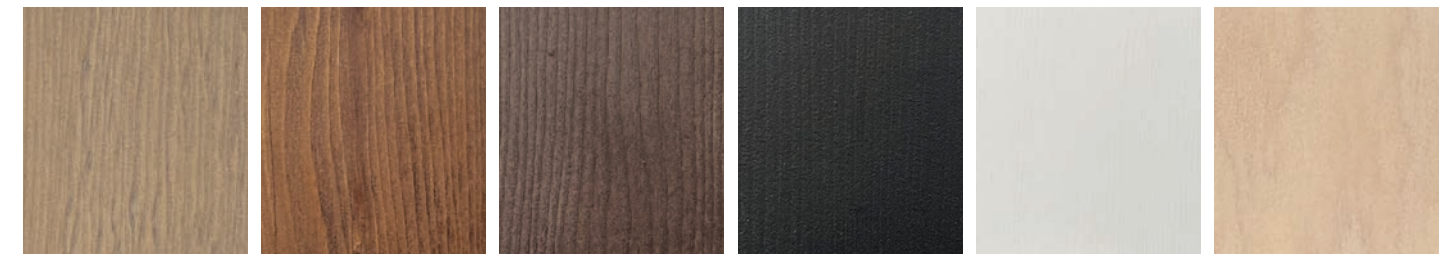

DRIFTWOOD FINISH (DRI)

WALNUT STAIN (WAL)

EBONY STAIN (EBO)

BLACK OPAQUE (BLA)

WHITE OPAQUE (WHI)

PICKLE FINISH (PIC)

NOTE: Alternate wood material options are available upon request including species, slat size, grain, stain color, finish system, and FSC certification.

Acoustic Panels - 2" Polyester Felt



Key Features

Medium-texture panel with soft visual and excellent noise control.

- 2" thick polyester felt panel
- Class A Fire Performance per ASTM E84
- Declare Label and Red List Free
- Post-consumer recycled content ranges between 65% - 81%
- End of Life Options: 100% recyclable and can be recycled at any polyester recycling facility
- Contains no VOCs, formaldehyde, paints, coatings, adhesive, sealants, or ozone depleting chemicals
- Color and texture may vary from panel to panel and from order to order



Available Colors

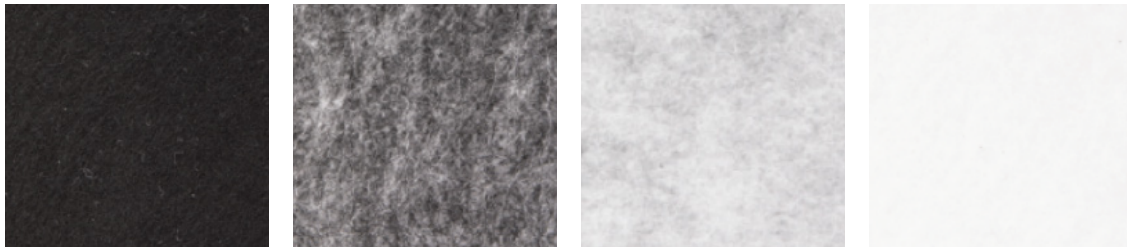

BLACK

CHARCOAL

LIGHT GRAY

WHITE

All finish panels are incorporated into Overcast torsion spring assemblies that, when released, allow the panel to swing down and be removed from below.

See finish panel manufacturer's website for additional product information.

Overcast reserves the right to substitute the manufacturer of the 2" polyester felt panel with a 2" polyester felt panel of equal or better quality and specification.

www.FSorb.com | info@FSorb.com | (844) 313-7672



Acoustic Panels - 1" Fiberglass Panel



OPTIMA®

Armstrong®
World Industries

Key Features

Fine-textured panels offer high sound absorption.

- 1" thick fiberglass panel with non-directional, smooth, clean durable finish
- High light-reflective finish with 0.88 light reflectance
- Part of Armstrong's CleanAssure™ family of products—includes disinfectable panels
- Washable, impact-resistant, scratch-resistant, and soil-resistant
- Mold and mildew-resistant surface
- Sag-resistant
- Class A Fire Performance per ASTM E84
- High Recycled Content—contains greater than 50% total recycled content. Total recycled content based on product composition of post-consumer and pre-consumer (post-industrial) recycled content per FTC guidelines

All finish panels are incorporated into Overcast torsion spring assemblies that, when released, allow the panel to swing down and be removed from below.

See finish panel manufacturer's website for additional product information.

TechLine (877) 276-7876 | armstrongceilings.com/optima



Acoustic Panels - 1" Polyester Felt

new FELTWORKS®

Armstrong®
World Industries

Key Features

Medium-texture panel with soft visual and excellent noise control.

- 1" thick polyester felt panel
- 0.78 light reflectance
- Part of Armstrong's CleanAssure™ family of products—includes disinfectable panels
- Mold and mildew-resistant surface
- Class A Fire Performance per ASTM E84
- Part of Armstrong's Sustain portfolio and meets the most stringent industry sustainability compliance standards today
- Product Certified for low chemical emissions -- Green Guard Gold Certified
- Color and texture may vary from panel to panel and from order to order

Available Colors - Due to printing limitations, shade may vary from actual product.



BLACK (FBL)

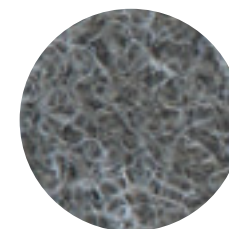

DARK GREY (FDG)



LIGHT GREY (FLG)



WHITE (FWH)



SUSTAIN®
High Performance
Sustainable
Ceiling Systems



All finish panels are incorporated into Overcast torsion spring assemblies that, when released, allow the panel to swing down and be removed from below.

See finish panel manufacturer's website for additional product information.

TechLine (877) 276-7876 | armstrongceilings.com/feltworks

Lighting Options

With linear direct, indirect, and downlight options available, Overcast products allow you to select the right lighting for your space.

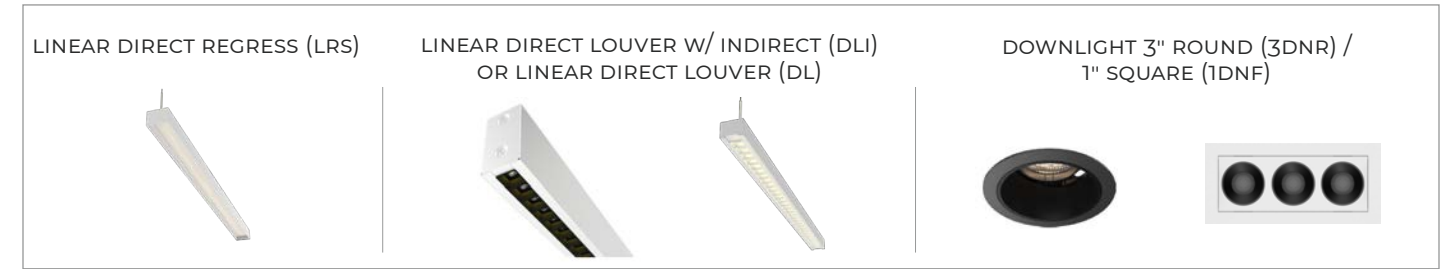

Style		Direct Lumen Output Range	Indirect Lumen Output Range	Color Temp		CRI	
MODULAR GRID	2DL 2' Direct Louver	See product data sheets for lumen packages available.	XX Not Applicable on Direct-only Fixtures	2700 2700K Color Temperature	80 80+ CRI (not available with 1DNF)	90 90+ CRI	
	4DL 4' Direct Louver			3000 3000K Color Temperature			
	6DL 6' Direct Louver			3500 3500K Color			
MODULAR GRID & CLOUD	3DNR 3" Downlight	See product data sheets for lumen packages available.	XX Not Applicable on Direct-only Fixtures	4000 4000K Color Temperature	ADJ 2700K - 6500K Adjustable White Color Temperature		
	1DNF1 1" Downlight, Fixed 1 Light						
	1DNF2 1" Downlight, Fixed 2 Light						
	1DNF3 1" Downlight, Fixed 3 Light						
	1DNF5 1" Downlight, Fixed 5 Light						
	1DNF10 1" Downlight, Fixed 10 Light						
CLOUD	4DR 4' Direct Regress	See product data sheets for lumen packages available.	XX Not Applicable on Direct-only Fixtures				
	6DR 6' Direct Regress						
	4DLI 4' Direct Louver with Indirect	See product data sheets for lumen packages available.	See product data sheets for lumen packages available.				
	6DLI 6' Direct Louver with Indirect						

Lens		Beam Angle		Reflector Type/Color		Trim Type/Color		Power		Dimming	
FR	Frosted Lens (DR/DL/DLI/3DNR)	SP	Spot, 20° (3DNR)	SMBL	Shade Matte Black (DL/DLI)	OPBL	Open Matte Black (3DNR)	120-277V	120-277V Standard	1*	0 - 10V Dimming 1%
CL	Clear Lens (DL/DLI)	NF	Narrow Flood, 24° (1DNF)	SGBL	Shade Glossy Black (DL/DLI)	PNBL	Pin-hole Matte Black (3DNR)	POE	Power Over Ethernet	0*	0 - 10V Dim to Off, Cloud IQ
FD	Focused Distribution, Collimating Lens (DR)	VF	Flood, 35/40° (3DNR/1DNS)	SMWH	Shade Matte White (DL/DLI)	GMBL	Gimbal Matte Black (3DNR)				
HC	Honeycomb Louver (3DNR accessory)	VF	Very Wide Flood, 60° (3DNR)	SGWH	Shade Glossy White (DL/DLI)	OPWH	Open Matte White (3DNR)				
		XX	Not Applicable on Linear Fixtures	BL	Matte Black (3DNR or 1DNF)	PNWH	Open Matte White (3DNR)				
				SS	Semi Specular (3DNR)	GMWH	Gimbal Matte White (3DNR)				
				SP	Specular (1DNF)	SFBL	Self Flanged Matte Black (1DNF)				
				WH	Matte White (3DNR)	SFWH	Self Flanged Matte White (1DNF)				
						XX	Not Applicable on Linear Fixtures				

* Driver compatible with specific controls systems available upon request.

Linear Regress Short (DR)



Specifications

Construction

- Custom powder-coated .050" aluminum housing
- Remote mount gear box for power supply/control equipment

Mounting and Installation

- Flush recessed into opening in Cloud
- Simple connection brackets to streamline fixture replacement

Optical

- Evenly diffuse flat regressed acrylic lens or collimating lens for improved UGR
- End to end illumination for even row lighting

Electrical

- LED Light Engine designed for reliability and long life operation
- Standard 0 - 10V dimming to 1% or 0-10 v dim to off
- 120 - 277V standard

Controls

- Individual or grouping control with many solutions available
- Consult factory for specific requirements

Listings

- Design Lights Consortium qualified, see DLC QPL
- ETL safety certified for damp locations
- Standard 5-year warranty/10-year warranty available upon request

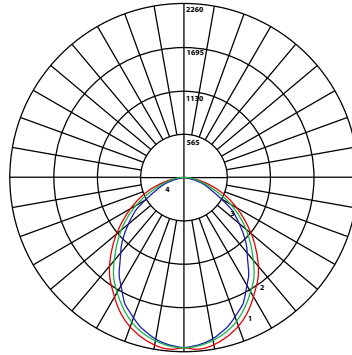

Max Candela = 2260, Horiz. Angle = 0., Vert. Angle = 5
 #1 - Vert. Plane through Horiz. Angles (0-180)
 #2 - Vert. Plane through Horiz. Angles (45-225)
 #3 - Vert. Plane through Horiz. Angles (90-270)
 #4 - Vert. Plane through Horiz. Angles (135-315)

DIMENSIONAL INFORMATION

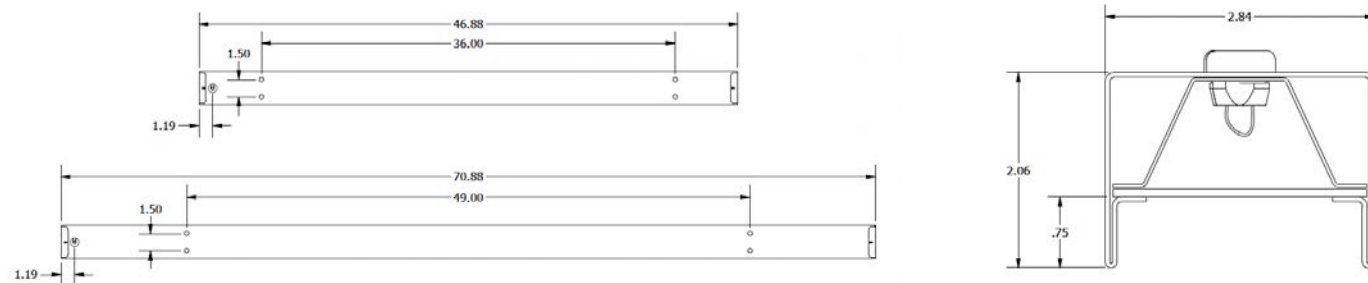

USA DESIGNED • USA MANUFACTURED • USA ASSEMBLED
 ENERGY SOLUTIONS INTERNATIONAL • WEST ST PAUL, MN • WWW.ESILIGHTING.COM • (651) 268 - 6060



Linear Louver Tall (DLI)



Specifications

Construction

- Custom powder-coated .050" aluminum housing
- Remote mount gear box for power supply/control equipment

Mounting and Installation

- Design integrates seamlessly into Overcast Cloud
- Simple connection brackets to streamline fixture replacement

Optical

- Unified Glare Rating of 5.7. UGR values range from 40 (extremely high glare) to 5 (very low glare)
- Injection-molded louver provides precise optical control limiting glare
- Shade available in white or black with a gloss or matte finish
- Frosted or clear downlight lens options
- Batwing optic for wide uplight distribution

Electrical

- LED Light Engine designed for reliability and long life operation
- Standard 0 - 10V dimming to 1% or 0-10 v dim to off
- 120 - 277V standard

Controls

- Individual or grouping control with many solutions available
- Consult factory for specific requirements

Listings

- Design Lights Consortium qualified, see DLC QPL
- ETL safety certified for damp locations
- Standard 5-year warranty/10-year warranty available upon request

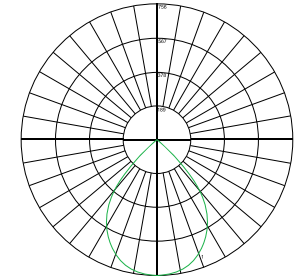
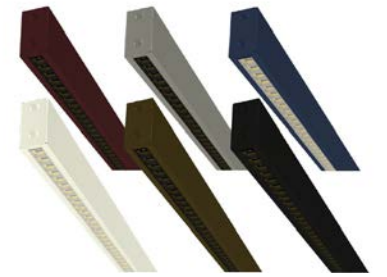

Max Candela = 756.403
 Horiz. Angle = 40., Vert. Angle = 1
 #1 - Vert. Plane through Horiz. Angles (40-220)
 #4 - Vert. Plane through Horiz. Angles (0-180)

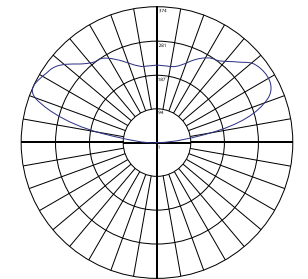

Max Candela = 374.1
 Horiz. Angle = 180., Vert. Angle = 115
 #1 - Vert. Plane through Horiz. Angles (180-0)

DIMENSIONAL INFORMATION

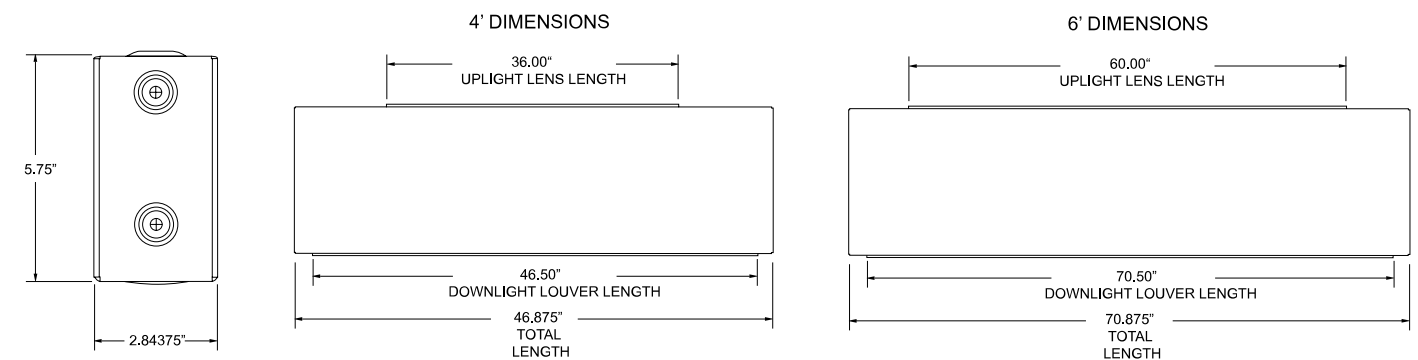

USA DESIGNED • USA MANUFACTURED • USA ASSEMBLED
 ENERGY SOLUTIONS INTERNATIONAL • WEST ST PAUL, MN • WWW.ESILIGHTING.COM • (651) 268 - 6060



Linear Louver Short (DL)



Specifications

Construction

- Custom powder-coated .050" aluminum housing
- Remote mount gear box for power supply/control equipment

Mounting and Installation

- Design integrates seamlessly into Overcast Cloud
- Simple connection brackets to streamline fixture replacement

Optical

- Unified Glare Rating of 5.7. UGR values range from 40 (extremely high glare) to 5 (very low glare).
- Injection-molded louver provides precise optical control limiting glare
- Shade available in white or black with a gloss or matte finish
- Frosted or clear downlight lens options

Electrical

- LED Light Engine designed for reliability and long life operation
- Standard 0 - 10V dimming to 1% or 0-10 v dim to off
- 120 - 277V standard

Controls

- Individual or grouping control with many solutions available
- Consult factory for specific requirements

Listings

- Design Lights Consortium qualified, see DLC QPL
- ETL safety certified for damp locations
- Standard 5-year warranty/10-year warranty available upon request

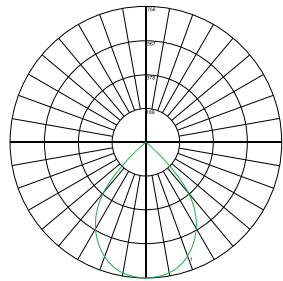

Max Candela = 756.403
 Horiz. Angle = 40°, Vert. Angle = 1°
 #1 - Vert. Plane through Horiz. Angles (40-220)
 #4 - Vert. Plane through Horiz. Angles (0-180)

DIMENSIONAL INFORMATION

SIZE	TOTAL LENGTH	MOUNTING LENGTH
2'	23.375"	20.375"
4'	47.375"	46.375"
6'	71.09375"	70.09375"

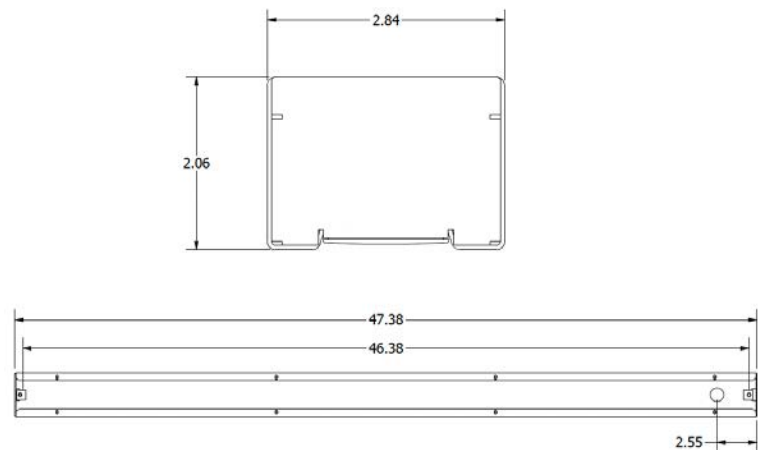

3" Downlight Round (3DNR)



Specifications

Construction

- Flexible 3" downlight system featuring many trim types and configuration options
- Multiple reflector finish options to match a wide range of ceiling applications
- Fixture rotates up to 355 degrees and tilts up to 30 degrees
- 3-piece fixture construction: LED Module, Trim & Housing
- Self-flanged trim with mouse trap style springs for mounting
- Die cast aluminum heat sink
- L80 lifetime of 50,000 hours
- Ambient fixture operating range: -4 degree F to 104 degree F

Mounting and Installation

- Self-flanged trim with mouse trap style springs for mounting and below ceiling changes

Optical

- UGR<19 for glare control designed to be an alternative to 3" MR16 fixtures

Electrical

- Universal 120-277V
- 0-10V driver available
- Drivers connect to LED modules using plenum rated, quick connect cable

Controls

- Individual Overcast Cloud control or grouped control with many solutions available
- Consult factory for specific requirements

Listings

- All combinations of fixtures, trims ETL listed for wet locations
- 5-year limited parts warranty

Finishes



Photometry

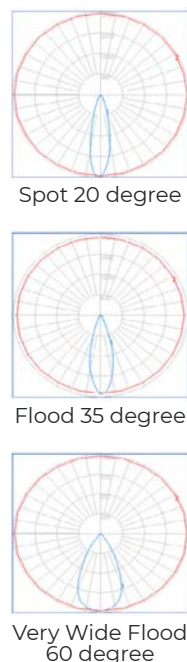

See manufacturer's product data for additional information.

Multiplier Tables

Shape	Conversion Factor
Round	1
Square	0.95

CRI	Conversion Factor
80	1.15
90	1

CCT	Conversion Factor
2700K	0.88
3000K	0.95
3500K	0.96
4000K	1.00

Trim Type	Conversion Factor
Open (OP)	1
Pinhole (PN)	0.70
Gimbal (GM)	0.85
Slot Aperture (SA)	0.55
Halo (All Colors)	0.10

Reflector Finish	Conversion Factor
Semi-Specular (SS)	0.98
Matte White (WH)	1.00
Gold (GD)	0.96
Matte Black (BL)	0.95

1" Downlight Fixed (1DNF)



Specifications

Construction

- Ultra-miniature fixed recessed, low glare luminaires
- Comes in 1 light, 2 light, 3 light, 5 light, 10 light sizes
- Other options available upon request including adjustable, ambient, wall washer, spotlight, and combo
- High efficiency at 104 lumens/watt
- Self-flanged trim with mouse trap style springs for mounting
- Die cast fixture body
- L70 lifetime of 50,000 hours
- Ambient fixture operating range: -4 degree F to 104 degree F

Mounting and Installation

- Self-flanged trim with mouse trap style springs for mounting and below ceiling changes

Optical

- Small light apertures deliver "quiet ceiling" lighting with minimal glare
- Produces a round beam pattern from a linear form factor fixture

Electrical

- -Universal 120-277V
- -0-10V driver available
- -Drivers connect to LED modules using plenum rated, quick connect cable

Controls

- Individual Overcast Cloud control or grouped control with many solutions available
- Consult factory for specific requirements

Listings

- ETL listed, wet location listing available in 3 light, 5 light, and 10 light sizes
- 5-year limited parts warranty

Fixture Finishes

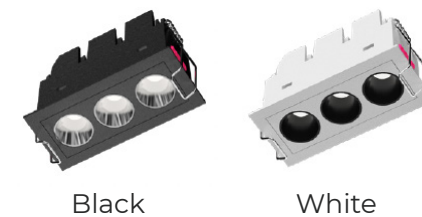

Reflector Finish

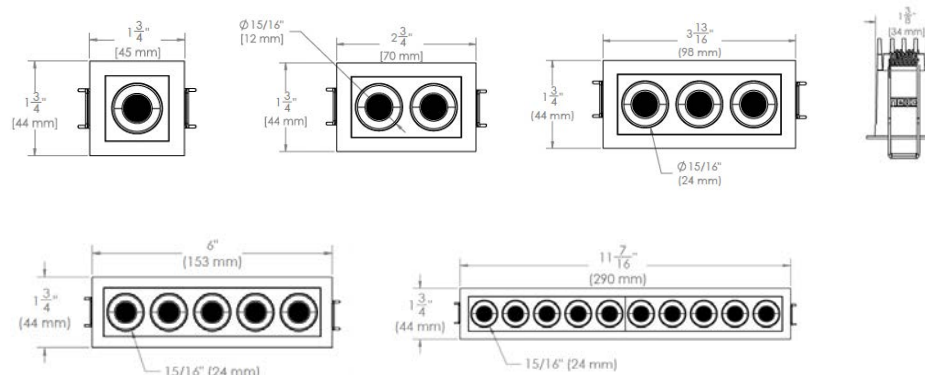
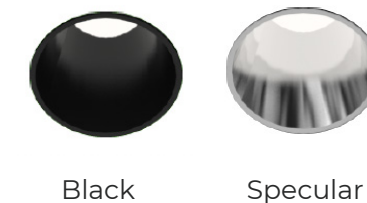

Photometry

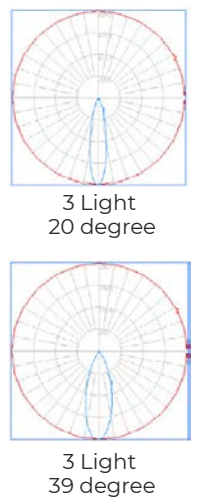

See manufacturer's product data for additional information.



Cloud Technology Configuration Options

Panel A		Panel B		Panel C		
Pos.1	Pos.3	Pos 5 (Mechanical)		Pos.7	Pos.8	Pos.9
Position 1 ²		Diffusers & Return Grilles		Position 7 ³		
OC1	Leviton, Occupancy Sensor	DP__	Architectural Plaque Diffuser, size range options include 8", 10", 12", or 14" with 'square to round' connection	AM	Sound Masking	
OC2	Crestron, Occupancy Sensor, Dual Tech	DM__	Modular Core Air Diffuser, size range options include 8", 10", 12", or 14" with 'square to round' connection	WIFI1	WIFI, Aruba	
OC3	NLight, Small Motion Occupancy Sensor	RG__	24"x24" Return Grille, Square with 'square to round' connection and 8", 10", 12", or 14" collars	WIFI2	WIFI, Ubiquiti	
OC4	NLight, Large Motion Occupancy Sensor	See product data sheets for additional product information. All Diffuser and Return Grilles can be fitted with a side inlet can if required.		WIFI3	WIFI, Cisco	
OC5	Enlighted, Occupancy Sensor	Air Filtration		XX	No Equipment	
MS1	Distech, Multi: Motion Only	AFS	StrataClean IQ, Air Filtration Unit	Position 8 ¹		
MS2	Distech, Multi: Motion, Daylight	Variable Refrigerant Flow (VRF)		AS	Audio Speaker	
MS3	Distech, Multi: Motion, Temp, Daylight	VM5	Mitsubishi, 2x2 Four-Way Cassette, 5k Btu/h	ASH	Audio Speaker, High-Bay	
		VM8	Mitsubishi, 2x2 Four-Way Cassette, 8k Btu/h			
MS4	Delta, O3 Sense Multi-Sensor	VM12	Mitsubishi, 2x2 Four-Way Cassette, 12k Btu/h	XX	No Equipment	
		VM15	Mitsubishi, 2x2 Four-Way Cassette, 15k Btu/h			
DS1	Leviton, Daylight Sensor	VM18	Mitsubishi, 2x2 Four-Way Cassette, 18k Btu/h	Position 9 ³		
		VS5	Samsung, 2x2 Four-way Cassette, 5k Btu/h			
XX	No Device in the Location	VS7	Samsung, 2x2 Four-way Cassette, 7k Btu/h	AQ⁴	Air Quality Sensor, Awair (or equivalent)	
		VS9	Samsung, 2x2 Four-way Cassette, 9k Btu/h			
XX	No Device in this Location	VS12	Samsung, 2x2 Four-Way Cassette 12k Btu/h	XX	No Equipment	
		VS18	Samsung, 2x2 Four-Way Cassette 18k Btu/h			
XX	No Device in this Location	VS20	Samsung, 2x2 Four-Way Cassette 20k Btu/h	¹ Audio speaker can reside in Panel C, Position 8 when a 6x6 Cloud is selected or Panel B, Position 5 in the 4x6 or 4x8 Cloud. ² For visual appearance, if only one device is selected in Panel A, placement will move to Position 2. ³ For visual appearance, if only one device is selected in Panel C, placement will move to Position 8. ⁴ AQ sensor can not be located within 4' of a fresh air source. AQ can not be mounted on the same Cloud as an AFS.		
		All VRFs are vibration isolation mounted 2x2 cassettes. See product data sheets for additional information.				
Position 3 ²		Other				
FAS01	Fire Alarm, Speaker Only	XX	No Equipment			
FASS1	Fire Alarm, Speaker and Strobe					
XX	No Device in this Location					

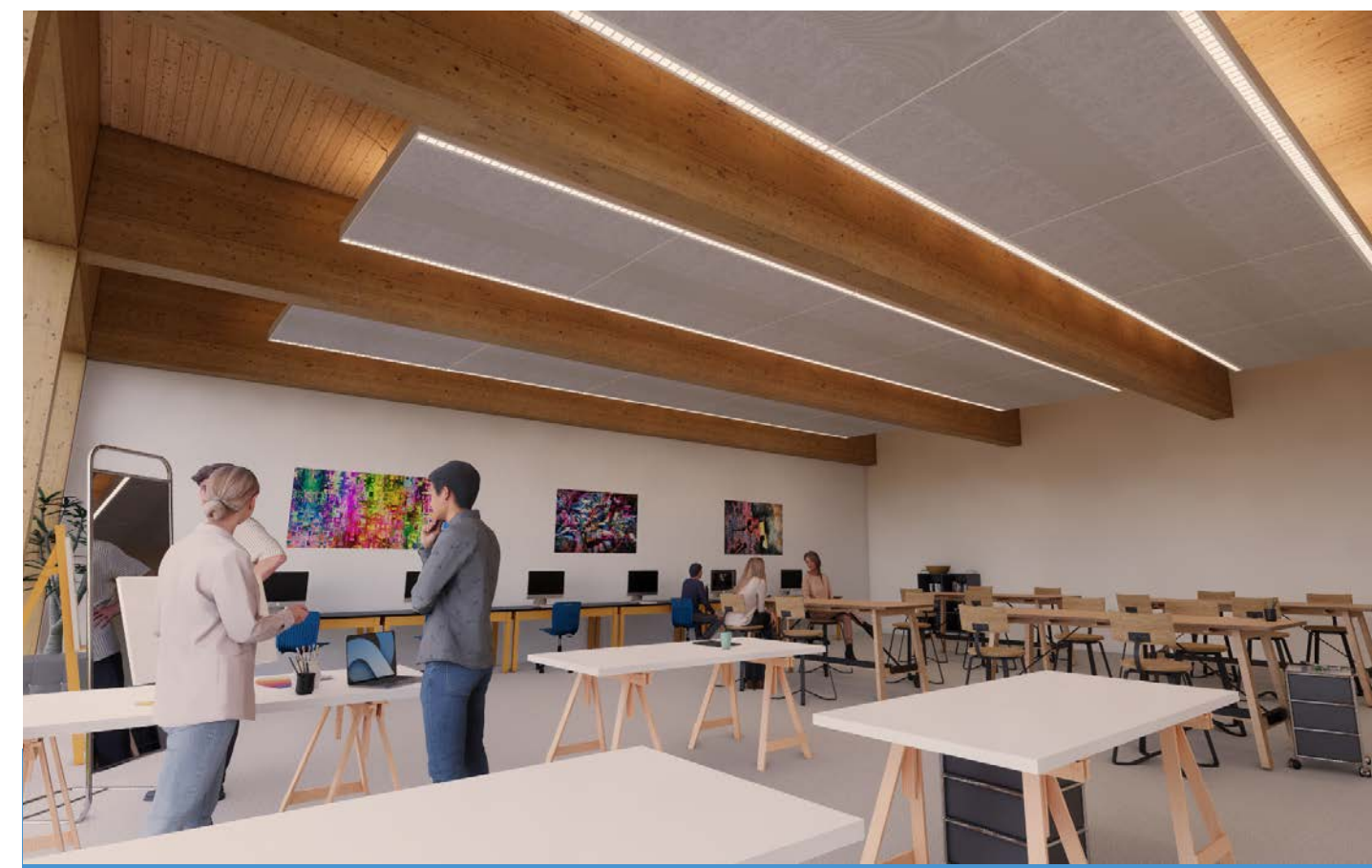
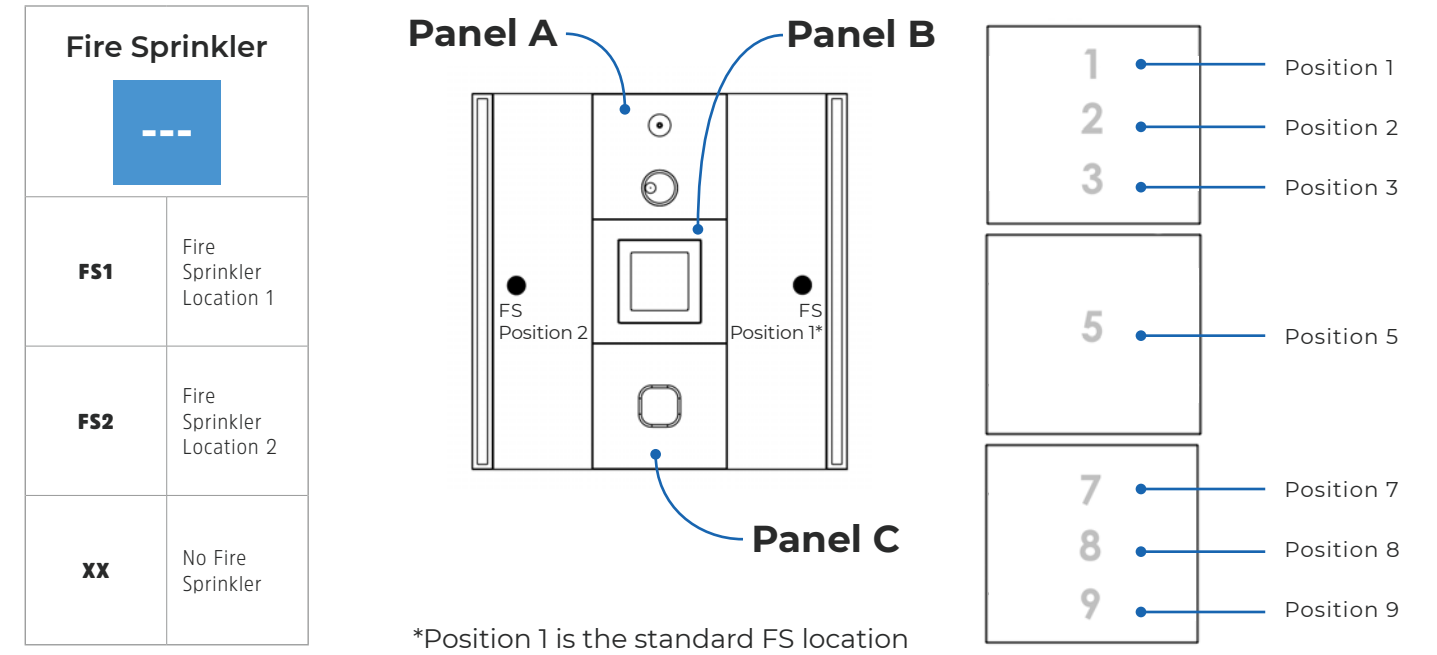

Mechanical Feature Details

Architectural Plaque Diffuser (DP)¹

Key Features

- Single plaque diffuser
- Designed for high volume air delivery
- Delivers supply air in a 360 degree pattern
- Hinged and removable core for easy duct access
- Rust resistant pre-coat with durable powder finish
- 2" ADC compliant round collar with bead for ease of installation



See Shoemaker website for performance details; same performance as the 'HL - Architectural High Volume Diffuser'

Modular Core Diffuser (DM)¹

Key Features

- Surface mount fixed blade grille with airfoil blades at 45°
- Adjustable modular cores
- Extruded aluminum frame
- Rust resistant pre-coat with durable powder finish
- 2" ADC compliant round collar with bead for ease of installation



See Shoemaker website for performance details; same performance as the 'MA' or '700 MA' products

Return Grille (R)¹

Key Features

- 1/2" x 1/2" x 1/2" aluminum lattice face return air grille
- Extruded aluminum frame
- 90% free area
- Rust resistant pre-coat with durable powder finish

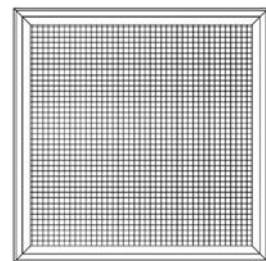

See Shoemaker website for performance details; same performance as the '600T' products

Variable Refrigerant Flow Unit (VRF)¹

Key Features

- 24 x 24 square design
- Cooling & heating capacity ranges vary (5,000 btu/hr to 18,000 btu/hr depending on model selected)
- Energy saving options available
- Multiple fan speed settings
- Condensate lift mechanism available



NOTE: Specific diffuser, return grille, and VRF features dependent on manufacturer make and model selected. Refer to manufacturer specifications for additional information. Example images above by Shoemaker Manufacturing & Samsung.

¹Diffuser & return grille panels can be specified with any of the standard colors offered. VRF unit colors are limited by manufacture's options which are typically white only.

Air Filtration System (AFS)



The quiet Armstrong StrataClean IQ™ Air Filtration System captures airborne contaminants, allergens, and particulates to create cleaner, healthier Indoor Air Quality (IAQ) for every space using proven MERV 13 filtration.¹

Key Features

- MERV 13 filtration with 3 fan speeds to optimize air changes per hour for your space
- In-ceiling air cleaning works up to 35% more effectively than floor-based air cleaning and is part of a long-term strategy to improve indoor air quality²
- Quiet operation -- as low as 29 dBA*
- No HVAC system integration required
- Energy efficient design uses only 15 watts -- less than a traditional incandescent light bulb*
- Integrates with occupancy sensors to save energy and maximize clean air while the space is occupied
- One unit filters the air for a 1,000 SF space every hour (1 filter = 1 Air Change per hour (ACH) for a 1,000 SF space)
- Can provide up to 2 ACH in a 1,000 SF room at a higher setting

*Operating at 150 CFM fan speed

How StrataClean IQ Works

StrataClean IQ uses an internal fan to draw air through one side of the square plaque diffuser, through a MERV 13 filter, and then discharge clean air back into the space through the opposite side of the square plaque diffuser.

NOTE: The Armstrong StrataClean IQ System is not a substitute for existing good building air exchange practices or manual cleaning and disinfection practices. Centrally locate and position clean air outtake away from HVAC returns for maximum benefit.

Construction

Zinc-coated 20-gauge steel housing. White powder coat finish for diffuser, 1000 HR salt spray rated. Assembly listed under UL507/CSA 22.2 No. 113

Electrical

- 9' 115V power cord
- Disconnect switch (DSW)

Filter

- MERV 13 Filter UL® Class 2 filter
- Filter Size: 21 x 11 x 2"
- Filter lifespan - 4,000 hrs

Warranty

1 Year

Assembled in the United States for Armstrong World Industries.

See Armstrong website for performance details and additional information.

¹ MERV 13 filter is at least 85% efficient at capturing particles in 1 µm to 3 µm size range. Source: <https://www.ashrae.org/technical-resources/filtration-and-disinfection-faq>

² A simulation study performed by JB&B showed that for equivalent cubic feet per minute (CFM), in-ceiling air purification delivered up to 35% lower particle concentration than a floor-based air purification unit across all sampled inhalation zones.

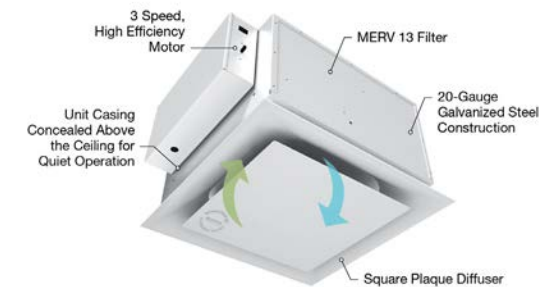

Standard Powder Coat Colors

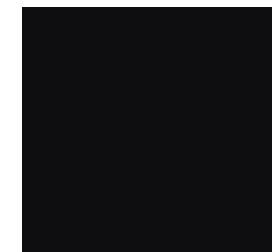

BLACK SATIN

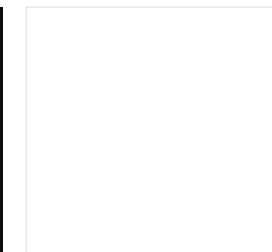

WHITE GLOSS

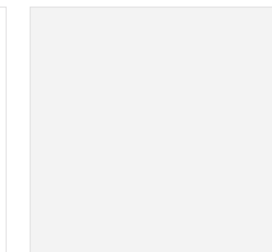

WHITE SATIN

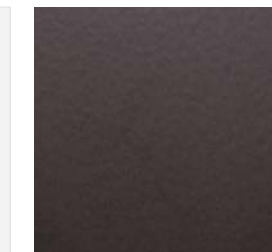

METALLIC GRAY



METALLIC SILVER

Premium Metallic Powder Coat

NOTE: Alternate powder coat colors are available upon request

Cloud Accessories

There are a series of additional accessories that may be desired depending on your project's requirements and location. Cloud accessories include:

- Enhanced Acoustics
- Cloud Hanging Kits
- Seismic Design Requirements

Enhanced Acoustics		Hanging Kits		Seismic Design Requirements
-- -		-- -		---
A0	Standard	CH	Cable Hangers (preferred approach in non-seismic designs)	Please check applicable box below if your project is in Seismic Design Category C, D, E, F
A1	Better	TR	Threaded Rod	Yes <input type="checkbox"/>
A2	Best	XX	Not Applicable	No <input type="checkbox"/>
See Seismic Design section for additional information				

Enhanced Acoustics

The Cloud system has a three-tiered approach to meet the individual needs of each space in your project. The standard offering includes a 2" layer of polyester fiber or recycled cotton insulation, depending on the finish selected. If increased absorption is required, we have developed "better" and "best" options that are achieved by adding an additional layer of acoustic insulation above each cloud. Added insulation is not visible from below. Laboratory testing is planned to determine how the performance of alternate finish materials will perform.

Noise Reduction Coefficient (NRC) of Cloud Array		
Product Option	Distance Between Clouds	
	0'	6'
A0 Standard	1.05	1.10
A1 Better	1.20	1.30
A2 Best	1.20	1.40

Modified Type J mount with cloud finished surface 54" from structure

Cloud Hanging Kits

Overcast provides hanging kits for your project. The kits include the appropriate anchors to connect to the structure above hangers and associated hardware.

Seismic Design

Each building project is assigned a seismic design category based on its occupancy category and the severity of the design earthquake ground motion at the project site. When a project has a seismic design category C, D, E, or F it will need to be designed to resist seismic forces and the project-specific design may require modifications to the standard Overcast hanging kit. Overcast will provide a project-specific deferred structural calculation submittal that includes the gravity and seismic design. The standard design includes threaded rods with a diameter sufficient to resist the seismic forces along with seismic cable bracing to resist lateral forces. See Overcast project proposal for details. Alternate bracing and stiffening methods will require analysis and may incur additional fees.

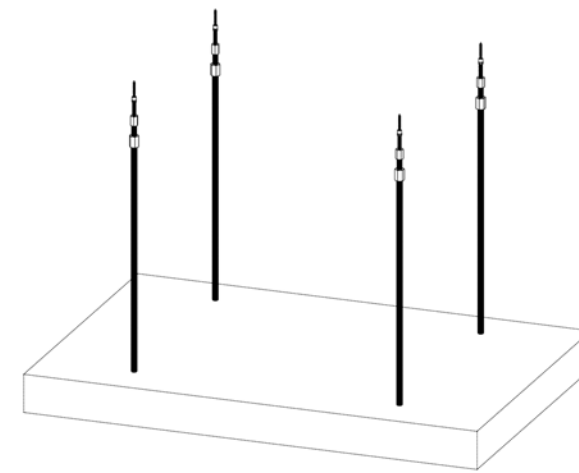

THREADED ROD HANGERS

(shown with increased rod diameter for seismic design)

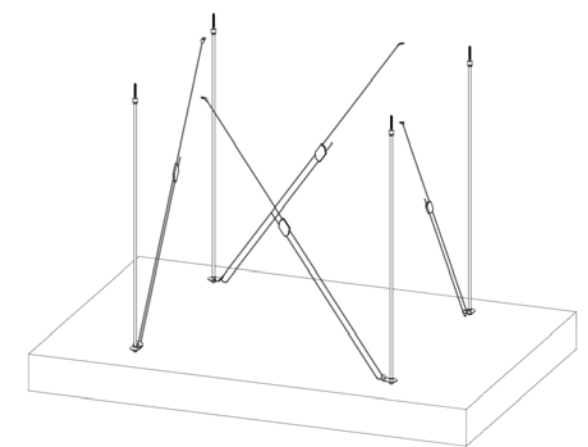

SEISMIC CABLE BRACING



Seismic Cable Bracing Features

- Fast installation time
- No tools required
- Complete pre-engineered system
- No field swaging of cables
- Color coding allowing for easy field verification from the ground

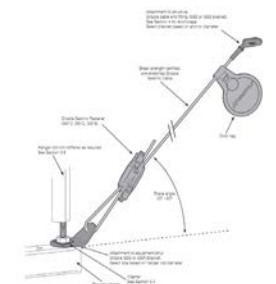

NOTE: Alternate rod stiffening options are available upon request. Seismic cable bracing option shown is a sample configuration.





Is the Overcast Cloud integrated ceiling product certified and does it have a UL Listed Mark (or comparable) certification mark?

- Overcast Innovations inquired with two laboratories, [Intertek Testing Services](#) (ETL Listed Mark) and [Underwriters Laboratories](#) (UL Listing Mark), listed in OSHA's Nationally Recognized Testing Laboratory (NRTL) Program in June 2020 about whether there is an appropriate product category for testing the Overcast Cloud integrated ceiling system. The engineers at both laboratories both indicated that there was no appropriate category for an integrated ceiling system product.
- It was determined that the Overcast Cloud is a combination of several listed products and the Cloud is an "integrator of certified products". They compared the Cloud to a wiring harness which is comprised of a series of products from different manufacturers. The laboratories also indicated that most safety and technical regulations revolve around processes that change the technical scope, category, ability, or characteristics of a given item and the cloud integrated ceiling system does not change any of these areas, nor does the cloud integration process change the integrated products use case or safety.
- Overcast verifies that all electrical and electronic components possess an NRTL Mark and have been tested against standards for electrical safety, electromagnetic compatibility, radio frequency compliance, energy efficiency and safety systems where applicable. Overcast also tracks the NRTL listings of all components utilized in the manufacturing of the cloud finished good, and an NRTL Listing report can be generated from the Overcast Product Lifecycle Management system based on project-specific component selections.

CERTIFICATE OF COMPLIANCE

SEISMIC DESIGN OF NONSTRUCTURAL COMPONENTS AND SYSTEMS



Certification No.

VMA-54057-01C (Revision 01)

Expiration Date: 10/31/2025

Certification Parameters:

The nonstructural products containing only non-active components listed on this certificate are CERTIFIED¹ FOR SEISMIC APPLICATIONS in accordance with the following building code² releases.

IBC 2021, 2018, 2015, 2012, 2009

The following model designations, options, and accessories are included in this certification. Reference report number **VMA-54057-01** as issued by VMC Group for a complete list of certified models, included accessories/options, and certified installation methods.

Overcast Innovations; Multiple Cloud 2.0 Integrated Ceiling System
Model; 4x4 to 4x8 & 6x6 to 6x8

The above referenced non-active components are **APPROVED** for seismic application when properly installed³, used as intended, and contains a Seismic Certification Label referencing this Certificate of Compliance. Approval is limited by the tabulated values, grade, and roof-level installations as shown in the chart below. Equipment Importance Factor assigned is $I_p=1.0$. The equipment is qualified by VMC Group via structural analysis of worst-case representative sample of certified product.

Certified Seismic Design Levels

Certified IBC	Importance $I_p = 1.0$ Soil Classes A-E Risk Categories I-IV Design Categories A-F	$z/h = 1.0$	$z/h \leq 0.0$
		$S_{Ds} \leq 2.3 g$	$S_{Ds} \leq 2.3 g$

Certified Seismic Installation Methods

Rigid Ceiling Suspension

HEADQUARTERS
113 Main Street
Bloomingdale, NJ 07403
Phone: 973.838.1780
Toll Free: 800.569.8423
Fax: 973.492.8430

CALIFORNIA
180 Promenade Circle
Suite 300
Sacramento, CA 95834
Phone: 916.634.7771

TEXAS
11930 Brittmoore Park Drive
Houston, TX 77041
Phone: 713.466.0003
Fax: 713.466.1355

thevmcgroup.com



CERTIFICATE OF COMPLIANCE

SEISMIC DESIGN OF NONSTRUCTURAL COMPONENTS AND SYSTEMS

Certified Product Table:

Model & Size	Size [in]		Weight [lb] ⁴	
	Length	Width	Min	Max
FG-00013; 4x8	95.75	47.75	116	236
FG-00014; 4x6	71.75	47.75	106	156
FG-00015; 4x6	71.75	47.75	94	181
FG-00016; 4x4	47.25	47.75	69	126
FG-00010; 4x6	47.25	71.75	93	170
FG-00011; 4x6	47.25	71.75	90	170
FG-00017; 4x8	47.25	95.75	109	207
FG-00018; 4x8	47.25	95.75	109	223
FG-00019; 6x8	95.75	71.75	160	250
FG-00020; 6x8	95.75	71.75	160	324
FG-00021; 6x8	71.75	95.75	145	310
FG-00022; 6x8	71.75	95.75	145	298
FG0009; 6x6	71.75	71.75	237	247
FG0006 6X6	71.75	71.75	110	210

The structural integrity of the CLOUD 2.0 fabricated parts and assemblies is analyzed and certified to withstand the listed seismic loading. Post seismic event functionality of the 3rd party devices termed as "Articles" by Overcast Innovations and their attachment to the CLOUD 2.0 fabricated parts and assemblies is not guaranteed.

Multiple Cloud integrated ceiling systems from sizes 4x4 to 6x8 with a max weight of 324 lbs. have been analyzed. The clouds were joined using aluminum or steel brackets attached with sheet metal screws. The brackets are attached to the frames. The joining distance ranges from 1/16" to 42" apart. The configurations are validated up to two clouds by five clouds. Contact manufacturer for further details and limitations of certification based on calculations and analysis performed.



VMA-54057-01C (Revision 01)
Issue Date: October 5, 2023
Expiration Date: October 31, 2025

HEADQUARTERS
113 Main Street
Bloomingdale, NJ 07403
Phone: 973.838.1780
Toll Free: 800.569.8423
Fax: 973.492.8430

CALIFORNIA
180 Promenade Circle
Suite 300
Sacramento, CA 95834
Phone: 916.634.7771

TEXAS
11930 Brittmoore Park Drive
Houston, TX 77041
Phone: 713.466.0003
Fax: 713.466.1355

thevmcgroup.com





VMC GROUP
THE POWER OF TOGETHER™



210 South Hudson Street
Seattle, WA 98134

info@overcastinnovations.com
overcastinnovations.com



CERTIFICATE OF COMPLIANCE

SEISMIC DESIGN OF NONSTRUCTURAL COMPONENTS AND SYSTEMS

Notes and Comments:

1. Worst case representative samples exhibiting least seismic capacity from all units listed herein was selected for structural analysis. Units were analyzed using seismic loading criteria for non-structural components as set forth in the ASCE 7 chapter 13. The analyzed units cited in this certification are representative sample(s) of a contingent of models and based on the analysis of selected units. All other listed unit sizes are deemed structurally sound to resist the mentioned seismic criteria. Although a seismically qualified unit inherently contains some wind resisting capacity, that capacity is undetermined and is excluded from this certification. Snow/Ice loads were not considered for this analysis.
2. The following building codes are addressed under this certification:
 - IBC 2021 – referencing ASCE7-16
 - IBC 2018 – referencing ASCE7-16
 - IBC 2015 – referencing ASCE7-10
 - IBC 2012 – referencing ASCE7-10
 - IBC 2009 – referencing ASCE7-05
3. Refer to the manufacturer supplied installation drawings for anchor requirements and mounting considerations for seismic applications. Required anchor locations, size, style, and load capacities (tension and shear) may be specified on the installation drawings or specified by a 3rd party. Mounting requirement details such as anchor brand, type, embedment depth, edge spacing, anchor-to-anchor spacing, concrete strength, special inspection, ceiling design, and attachment to non-building structures must be outlined and approved by the Engineer of Record for the project or building. Structural supports must also be seismically designed and approved by the project or building Structural Engineer of Record to withstand the seismic anchor loads as defined on the installation drawings. The installation contractor is responsible for observing the installation detailed in the seismic installation drawings and the proper installation of all anchors and mounting hardware.
4. Weight of units should not exceed weight listed in the certified product table.
5. Where applicable, Mechanical, Electrical, and Plumbing connections to the equipment supported to units must be flexibly attached so as to not transfer load through the connection. The structural integrity of any conduit, cable trays, piping, ductwork and/or flexible connections is the responsibility of others. This certification does not guarantee the unit will remain compliant to NEMA, IP, UL, or CSA standards after a seismic event.
6. This certificate applies to units manufactured at:
9470 W 21st Suite 102, Spokane, Washington 99224

John P. Giuliano, PE
President, The VMC Group

VMA-54057-01C (Revision 01)
Issue Date: October 5, 2023
Expiration Date: October 31, 2025



HEADQUARTERS
113 Main Street
Bloomingdale, NJ 07403
Phone: 973.838.1780
Toll Free: 800.569.8423
Fax: 973.492.8430

CALIFORNIA
180 Promenade Circle
Suite 300
Sacramento, CA 95834
Phone: 916.634.7771

TEXAS
11930 Brittmoore Park Drive
Houston, TX 77041
Phone: 713.466.0003
Fax: 713.466.1355

thevmcgroup.com



Overcast Innovations, LLC Warranty

Performance of the work

Overcast shall perform the scope of work ("Work") specified herein. Overcast shall furnish all services necessary to perform the Work and perform the Work to completion diligently, expeditiously and with adequate forces. Customer shall use its best efforts to provide all information, materials, documents, and assistance that is reasonably required for Overcast to perform any and all aspects of the Work.

1. Product Sales

- 1.1 Purchase Orders. Customer will order Product from Overcast by issuance of a written purchase order ("PO"). Customer may not cancel or reschedule a PO without written approval of Overcast. The terms and conditions of this agreement take precedence over any terms and conditions included with any PO. Overcast reserves the right to accept or reject each PO.
- 1.2 Price. Unless otherwise mutually agreed upon by the Parties in writing, the purchase price for a Product will be as specified in the then-current price list provided by Overcast to Customer as of the date Overcast receives a PO ("Price"). The Price is exclusive of sales, use, excise, or value added tax, which will be payable by Customer. If Customer provides to Overcast a valid tax exemption certificate, Overcast will not collect the taxes covered by the certificate.
- 1.3 Shipping. Overcast will ship Product pursuant to an accepted PO to Customer FOB destination, with title and risk of loss passing from Overcast to Customer at the designated delivery destination. Partial deliveries as well as deliveries by distributors, agents and other third parties shall be permitted, unless otherwise agreed upon in writing by the Parties.
- 1.4 Payment. Overcast will invoice Customer for the applicable Product Price as follows: (a) 50% of the total Price of Products ordered following Overcast's acceptance of a PO; (b) 40% of such Price following Overcast's delivery of such Products to Customer; and (c) 10% of such Price following the earlier of the date of installation of such Products or [30 days after delivery thereof]. Customer will make full payment for each invoice within [30] days after the date of Overcast's invoice [by wire with immediately available funds to the bank account designated by Overcast]. Any payments due to Overcast that are not timely received will be subject to interest accrued at the lesser of 1.5% per month or the maximum amount permitted by law.

2. Product Warranty

- 2.1 Overcast Warranty. Subject to the exclusions in Section 2.2, for the [12-month] period immediately following Substantial Completion to Customer ("Warranty Period"), Overcast warrants against defects in materials or workmanship.
- 2.2 Warranty Exclusions. Overcast will have no liability for any breach of Section 2.1 to the extent such breach is caused by: (a) installation or commissioning (including configuration, inspection and test) activities performed by anyone other than Overcast; (b) misuse, mishandling, neglect, improper storage, accident, or negligent operation or maintenance of any Product; (c) modifications (including repair) to the Product made by anyone other than Overcast; (d) flood, fire, theft, vandalism, or other external cause of damage; (e) reasonable wear and tear; or (f) damage or defects arising from use outside of operating specifications or other documentation provided by Overcast; or (g) damage or defects caused by Third-Party Materials (defined in Section 2.5 below).
- 2.3 Warranty Remedy. Subject to Customer's compliance with the terms of Section 2.4, during the Warranty Period, Overcast will, at its expense and sole discretion, repair, replace, or refund the Price paid by Customer for any Product that fails to conform to the warranty in Section 2.1 ("Defect"). This remedy is Customer's sole and exclusive remedy, and Overcast's sole and exclusive liability, for any Defect.



2.4 Product Returns. Customer will, at its expense, return any Defect to Overcast in accordance with Overcast's instructions [within 30 days of discovering any Defect]. Customer will bear risk of loss on the returned Defect until delivered to Overcast. Title to any Defect will pass to Overcast upon the date which Overcast provides any replacement or refund for such Defect. In the event of a disagreement between Overcast and Customer over the existence of a Defect or warranty exclusion, the results of Overcast's reasonable testing and diagnostics will be conclusive.

2.5 Third-Party Materials. The Product is designed to be integrated with third-party components, software, and systems ("Third-Party Materials"). As a convenience to Customer, Overcast may procure and deliver Third-Party Materials for Customer. Overcast will not be responsible or liable for Third-Party Materials, and the warranty in section 2.1 does not apply to Third-Party Materials. Customer will comply with, and will be solely responsible for complying with, any terms and conditions, including any software license terms, applicable to the Third-Party Materials.

2.6 Recall. Customer will promptly provide Overcast written notice of all Product safety issues of which it becomes aware. Customer will reasonably assist Overcast in its Product safety issue investigation and response, including by providing Overcast with access to the physical Products giving rise to any safety issue. Customer will cease use of the Products, and promptly return the Products, upon receiving notice from Overcast of a Product recall. In connection with any such recall, Overcast will either repair, replace or refund the purchase Price for such recalled Product. This remedy is Customer's sole and exclusive remedy, and Overcast's sole and exclusive liability, for any recalled Product.

3. Confidentiality.

3.1 Definition. "Confidential Information" means information that one Party (or its affiliate) discloses to the other Party (or its affiliate) in connection with this Agreement, and that is marked as confidential or would normally be considered confidential information under the circumstances.

3.2 Exclusions. The obligations under Section 3.2 will not apply to information that is independently developed by the recipient, is rightfully given to the recipient by a third party without confidentiality obligations or becomes public through no fault of the recipient or unauthorized act of any third party.

4. Defense and Indemnity.

4.1 Overcast Obligations. Overcast will, at its expense, defend and indemnify Customer from and against third-party lawsuits, claims, demands, investigations and actions, and associated liabilities, losses, damages, costs and expenses (including reasonable attorneys' fees and court costs), to the extent arising from an allegation or claim related to the Product's direct infringement or misappropriation of a third-party's U.S. intellectual property rights.

4.2 Customer's Obligations. Customer will, at its expense, defend and indemnify Overcast and its affiliates from and against third-party lawsuits, claims, demands, investigations and actions, and associated liabilities, losses, damages, costs and expenses (including reasonable attorneys' fees and court costs), to the extent arising from an allegation or claim related to Customer's breach of the Agreement or any operation, installation or use of the Product in violation of operating or storage conditions, documentation or other written specifications provided by Overcast.

4.3 Exclusions. This Section 4 will not apply to the extent the underlying allegation or claim arises from: (a) an indemnified Party's breach of this Agreement, negligence, fraud or willful misconduct; or (b) in the case of Overcast's obligations under Section 4.1, modification of the Product by anyone other than Overcast, combination of the Product with any Third-Party Materials, Overcast's compliance with designs or specifications provided by Customer, or use of the Product in an application or environment for which it was not designed.

4.4 Overcast Options. If a Product is held to infringe, distribution is enjoined, or Overcast reasonably believes that any Product may become subject to a claim of infringement or misappropriation, then Overcast will have the right at its option to: (a) procure the rights necessary for Customer to continue to use the Product in the application for which it was designed; (b) modify the Product to make it non-infringing; or (c) if Overcast believes neither of the foregoing is commercially practicable, refund the Price paid for



such Product. If Overcast provides a remedy under Section 4.4(c), then Customer will immediately thereafter discontinue all use of the Product. Any remedy provided by Overcast under this section will be Customer's sole and exclusive remedy, and Overcast's only liability, for any actual or alleged infringement or misappropriation by the Product of intellectual property rights of a third party.

5. Limitation of Liability.

5.1 Limitations. SUBJECT TO SECTION 5.2, (A) NEITHER PARTY WILL HAVE ANY LIABILITY ARISING OUT OF OR RELATING TO THIS AGREEMENT FOR LOST PROFITS OR INDIRECT, SPECIAL, INCIDENTAL, EXEMPLARY, PUNITIVE OR CONSEQUENTIAL DAMAGES (WHETHER OR NOT FORESEEABLE OR CONTEMPLATED BY THE PARTIES AT THE EFFECTIVE DATE); AND (B) THE AGGREGATE LIABILITY OF EACH PARTY UNDER THIS AGREEMENT WILL NOT EXCEED THE AMOUNT PAID BY CUSTOMER TO OVERCAST FOR THE PRODUCT(S) GIVING RISE TO THE CLAIM.

5.2 Exceptions to Limitations. Nothing in this Agreement excludes or limits either Party's liability for: (a) in the case of Customer, Customer's payment obligations under this Agreement; and (b) in the case of either Party, its fraud or fraudulent misrepresentation, its breach of Section 3, its infringement or misappropriation of the other Party's intellectual property rights or matters for which liability cannot be excluded or limited under applicable law.

6. Term and Termination.

6.1 Termination for Convenience. Either Party may terminate this Agreement at any time by giving the other Party at least 30 days' written notice.

6.2 Effect of Termination. Upon termination of this Agreement: (a) Customer will immediately pay to Overcast all outstanding amounts owed as of the date of termination; and (b) if requested by a Party, the other Party will use its reasonable efforts to promptly return, or destroy and confirm in writing the destruction of, all Confidential Information disclosed to it by the requesting Party. Any provisions which by their nature should survive termination of this Agreement will survive.

7. General Terms.

7.1 Publicity. Neither Party may make any public statement regarding this Agreement without the other's prior written approval.

7.2 No Waiver. Neither Party will be treated as having waived any rights by not exercising (or delaying the exercise of) any rights under this Agreement.

7.3 No Agency. This Agreement does not create any agency, partnership, or joint venture between the Parties.

7.4 No Third-Party Beneficiaries. This Agreement does not confer any benefits on any third party unless it expressly states that it does.

7.5 Governing Law. This Agreement will be governed by the laws of the State of Washington, excluding conflict of law rules. Each Party agrees to submit to the personal and exclusive jurisdiction of the courts located in King County, Washington.

7.6 Force Majeure. Neither Party will be liable for any failure to perform due to events or circumstances beyond its reasonable control, whether or not foreseeable, including acts of God, war, riot, embargoes, acts of civil or military authorities, epidemic or pandemic, delay in delivery by Overcast's suppliers, fire, flood, accident, strikes, inability to secure transportation, facilities, fuel, energy, labor or materials. In the event of force majeure, Overcast's time for delivery or other performance will be extended for a period equal to the duration of the delay caused thereby.

7.7 Construction. The word "include" (including all conjugations) is intended to be exemplary, not exhaustive, and will be deemed followed by "without limitation," and the word "or" means both "and" and "or," except where the context clearly indicates that the parties intend "or" to designate alternatives only.

7.8 Notices. Unless otherwise specified in this Agreement, all notices required or permitted under this Agreement will be in writing and delivered by email to the respective email addresses set forth in the signature block below or as otherwise updated through notice



by a Party to the other Party, effective on receipt, as verified by written or automated receipt or by electronic log (as applicable). In addition, if notice is from Customer to Overcast then notice will be in writing and delivered to: General Counsel, Overcast Innovations, LLC, 5005 3rd Ave S., Seattle, WA 98134.

7.9 Severability. If any term (or part of a term) of this Agreement is invalid, illegal, or unenforceable, the rest of the Agreement will remain in effect.

7.10 Amendments. Any amendment to this Agreement must be in writing, signed by the Parties, and expressly state that it is amending this Agreement.

7.11 Counterparts. The Parties may execute this Agreement in counterparts, including facsimile, PDF, and other electronic copies, which taken together will constitute one instrument.

7.12 Entire Agreement. This Agreement sets out all terms agreed between the Parties regarding their performance hereunder and supersedes all other agreements between the Parties relating to its subject matter. Any terms and conditions stated on a Customer-issued PO will be void. In entering into this Agreement no Party has relied on, and no Party will have any right or remedy based on, any statement, representation, or warranty (whether made negligently or innocently), except those expressly set out in this Agreement





www.overcastinnovations.com
[linkedin.com/company/overcast-innovations-llc/](https://www.linkedin.com/company/overcast-innovations-llc/)

Product development is a process of continuous improvement & the Overcast catalog is subject to change without notice. Consult your sales representative, sales engineer, or applied engineer for current configurations, options, and future product updates.
Printed in USA, Rev 2.

© 2023 Overcast Innovations LLC. OVERCAST and the Cloud Logo are registered trademarks of Overcast Innovations LLC. All third-party product names, company names, trademarks, service marks or certification marks are the exclusive property of their respective owners. Use of third-party trademarks is not intended to identify the product and does not imply affiliation, sponsorship or endorsement with the mark owner. The PEFC Logo is a trademark of the PEFC Council (PEFC International). ENERGY SOLUTIONS INTERNATIONAL, INC. and the Globe Logo are trademarks of Energy Solutions International, Inc. GRIPPLE and the G GRIPPLE Logo are trademarks of Gripple Limited. VMC GROUP, the VMC Logo and THE POWER OF TOGETHER are trademarks of Vibration Mountings & Controls, Inc. MITSUBISHI is a trademark of Mitsubishi Corporation. SHOEMAKER MANUFACTURING is a trademark of Shoemaker Manufacturing Company. Declare® and Living Building Challenge® (LBC) are registered trademarks of the International Living Future Institute®; WELL™ and WELL Building Standard are trademarks of the International WELL Building Institute; UL and UL Certified and UL Greenguard are trademarks of UL LLC. Armstrong®, OPTIMA® and STRATACLEAN™ are the registered trademarks of Armstrong World Industries, Inc. FSorb is a registered trademark of Nut Shell LLC. SAMSUNG is a trademark of Samsung Electronics Co., Ltd.