

METALWORKS™ Shapes for DESIGNFLEX®

Tegular
smooth texture

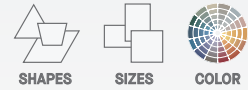

DESIGNFLEX® CEILING SYSTEMS

PERSONALIZE YOUR DESIGN!

Mix and match different sizes, shapes, colors, and materials to reinvent your ceiling. More at: armstrongceilings.com/designflex



MetalWorks Shapes for DesignFlex with Suprafine® XM 9/16" suspension system

Now, MetalWorks™ Shapes in 45° and 60° triangles, parallelograms, and trapezoids.

KEY SELECTION ATTRIBUTES

- DesignFlex® options mean shapes, sizes, and colors
- Mix and match – Shapes also available with Calla®, Lyra®, Ultima®, Optima®, and WoodWorks® panels
- MetalWorks panels are part of the Sustain™ portfolio, and meet the most stringent industry sustainability compliance standards today
- CleanAssure™ family of products – includes disinfectable panels, suspension systems, and trim
- Lighting and MEP integration with TechZone®, or with shaped lights and diffusers, available through one of our partner companies, or with standard modular and pendant lights
- Aluminum panels with exceptional durability – Washable, Scrubbable, Soil-resistant

COLORS Due to printing limitations, shade may vary from actual product.

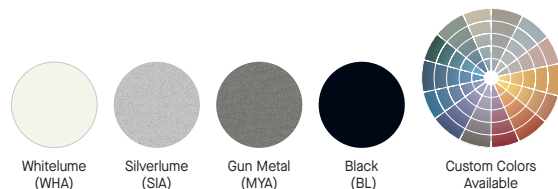

These colors are part of the Sustain portfolio (M1 – unperforated panels only)

PERFORATION OPTIONS (1:2 scale shown)



DETAILS

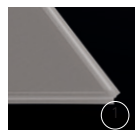

1. MetalWorks Shapes for DesignFlex Tegular in M1 unperforated

METALWORKS™ Shapes for DESIGNFLEX®

Tegular
smooth texture



Declare.

LEED WELL LBC

UP TO 25% RECYCLED CONTENT

energy management
construction waste mgmt
regional materials
design for flexibility
EPD
recyclable/ bio-based materials
producer resp.

biobased materials
recycled content
sourcing of low materials
material ingredient reporting
low emitting materials
lighting quality
acoustics

For LEED contribution contact TechLine

LOCATION DEPENDENT

WITH INFILL PANEL

Start your design process with a visit to our online pattern gallery at: armstrongceilings.com/patterngallery

See dozens of pre-designed patterns and colors online in our pattern gallery. We've provided all of the details – from takeoffs showing 2' or 4' on-center spacing to panels, suspension, trims, and accessories. Installation instructions answer questions typically associated with unique ceiling installations. Lighting and air diffusers can also be easily integrated. If you can't find the ceiling pattern you envision for your next space online, call us and we'll help you create a design to personalize your space – 1 877 276-7876.



These 8 MetalWorks™ Shapes with Tegular edges are available for Suprafine® XM 9/16" suspension:

45° SHAPES

Triangles

2' Main Beam Spacing **8284M1** ___ Triangle

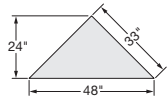

Panel 5/16" thick

Item No. ◆ Description/
Dimensions
(Inches)

8285M1 ___ Right Triangle



Panel 5/16" thick

Parallelograms

2' Main Beam Spacing **8287M1** ___ Right Parallelo-gram

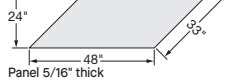

Panel 5/16" thick

8288M1 ___ Left Parallelogram

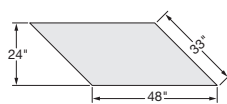

Panel 5/16" thick

Trapezoids

No Trapezoids available in 45° shapes

60° SHAPES

Triangles

2' Main Beam Spacing **8290M1** ___ Triangle

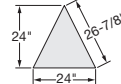

Panel 5/16" thick

Item No. ◆ Description/
Dimensions
(Inches)

Parallelograms

2' Main Beam Spacing **8292M1** ___ Right Parallelo-gram



Panel 5/16" thick

8293M1 ___ Left Parallelogram

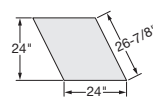

Panel 5/16" thick

Trapezoids

2' Main Beam Spacing **8296M1** ___ Trapezoid

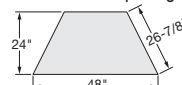

Panel 5/16" thick

◆ When specifying or ordering, include the appropriate perforation and color suffix with the item number (e.g. 8284M1 W H A).

SUSPENSION SYSTEMS

9/16"

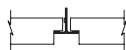

Suprafine® XM
for Shapes

Suspension system is available in coordinating colors

TechLine 877 276-7876
armstrongceilings.com/metalworksshapes

Armstrong®
World Industries

DESIGNFLEX® SHAPES



METALWORKS™ Shapes for DESIGNFLEX®

Tegular
smooth texture



Declare.

LEED WELL | LBC
UP TO 25% RECYCLED CONTENT

energy management	construction waste mgmt	regional materials	design for flexibility	EPD	recycle/extended producer resp.	biobased materials	recycled content	sourcing of raw materials	material ingredient reporting	low emitting materials	lighting quality	acoustics
-------------------	-------------------------	--------------------	------------------------	-----	---------------------------------	--------------------	------------------	---------------------------	-------------------------------	------------------------	------------------	-----------

For LEED contribution contact TechLine

LOCATION DEPENDENT

WITH INFILL PANEL

DETAILS

Tegular Panel installed with Angle Bracket connecting Suprafine® XM Cross Tee and Main Beam

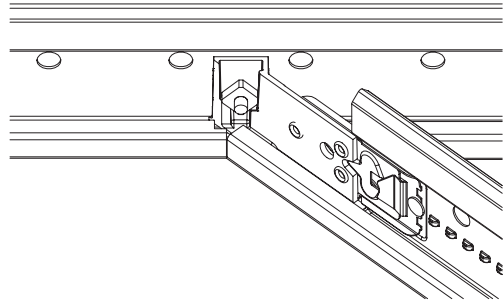

Full-size Tegular Panel Axiom® Trim Perimeter Solution, using AXTBC Clip

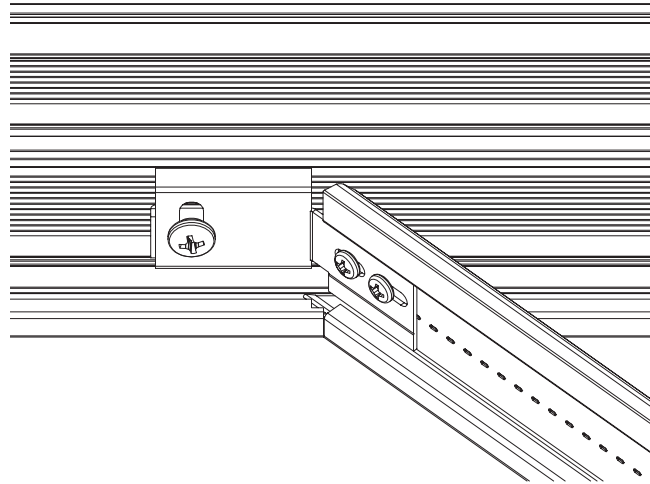

SUSPENSION SYSTEMS

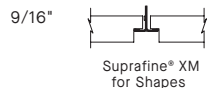

Suspension system is available in coordinating colors

PARTNER COMPANIES

For more information on our partner companies, please visit armstrongceilings.com/partners

Compatible with:
Axis Geometrix™ Lighting,
JLC-Tech T-BAR FLEX LED
Lights and Price diffusers.



Shaped infill panels are available through asquote@armstrongceilings.com for specific partner lighting fixtures.

PHYSICAL DATA

Material
Aluminum – thickness 0.040"

Surface Finish
Factory-applied polyester paint finish
Custom colors also available. Contact TechLine for custom color matching requests at 1 877 276-7876.

Fire Performance
Class A per ASTM 84. Flame Spread Index 25 or less. Smoke Developed Index 50 or less. CAN/ULC S102 Flame Spread 25 or less. Smoke Developed Index 50 or less.

ASTM E1264 Classification
Fire Class – Class A
Unperforated – Type XX, Pattern G
Perforated – Type XX, Pattern C

Installation Considerations
See installation instructions for bracket and perimeter solution guidelines.

Design Considerations
MetalWorks™ Shapes for DesignFlex® installation system based on parallel main beam spacing.
WHA, SIA, and MYA will not match WH, SG, and MY used on other substrate products.
Silverlume (SIA) and Gun Metal (MYA) colors are directional and run parallel to base as shown on data page. This must be considered in ceiling layout plans for right triangle shape.
For optimum visual design, backlighting panels is not recommended.
For any color available contact: asquote@armstrongceilings.com

Seismic Restraint
Suprafine XM for DesignFlex Shapes suspension system have been engineered, tested, and approved for use with DesignFlex Shapes panels when installed per Armstrong Ceilings installation instructions.

Cleaning and Disinfecting
Cleaning and CDC approved disinfecting options available on armstrongceilings.com/cleaning

Warranty
Details at armstrongceilings.com/warranty

Weight/Panel (Bulk Packed)

8284M1 – 2.2 lbs/SF	8290M1 – 1.1 lbs/SF
8285M1 – 1.1 lbs/SF	8292M1 – 2.2 lbs/SF
8287M1 – 4.4 lbs/SF	8293M1 – 2.2 lbs/SF
8288M1 – 4.4 lbs/SF	8296M1 – 3.3 lbs/SF







SUSPENSION SYSTEMS COMPONENTS & ACCESSORIES System utilizes Suprafine® XL® main beams

45° SHAPES

Item No.	Description
75AB45L	Suprafine® 45° Left Angle Bracket 
75AB45R	Suprafine 45° Right Angle Bracket 
75AB45D	Suprafine 45° Double Angle Bracket 
75CB45	Suprafine 45° Corner Bracket 
XM754524	Suprafine 45° Base Cross Tee – 24" Main Beam Spacing
XL7520	24" Suprafine Cross Tee
XM7524	Suprafine Perimeter Cross Tee – 24" Main Beam Spacing
PCC	Axiom® Perimeter Corner Clip 
PAC	Perimeter Angle Clip 
BERC2	2" Beam End Retaining Clip 

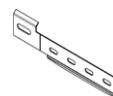
60° SHAPES

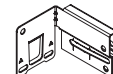
Item No.	Description
75AB60L	Suprafine 60° Left Angle Bracket 
75AB60R	Suprafine 60° Right Angle Bracket 
75AB60D	Suprafine 60° Double Angle Bracket 
XM756024	Suprafine 60° Base Cross Tee – 24" Main Beam Spacing
XM7524	Suprafine Perimeter Cross Tee – 24" Main Beam Spacing
PCC	Axiom Perimeter Corner Clip 
PAC	Perimeter Angle Clip 
BERC2	2" Beam End Retaining Clip 

For additional suspension components, trims, and clips, please consult the full installation instructions at www.armstrongceilings.com/shapesinstallation

