

LIGHTING SOLUTIONS

Intersection Downlighting for Acoustical Ceilings



Armstrong acoustical panels with USAI Lighting Connect light fixtures

This pre-engineered suspension system seamlessly integrates recessed downlights at the intersection of the ceiling grid, placing light where it has never been before.

KEY SELECTION ATTRIBUTES

- Lighting and architecture perfectly integrated into the ceiling to deliver your vision of symmetry
- Replaces inconsistent finishes and edge details with clean crisp factory finished panels and grid for a fast and easy installation
- Compatible with the USAI Lighting CONNECT™ Family
- Eliminates the worry of field modified panels and grid
- Seismic code compliant
- Armstrong 10-Year Limited Warranty

COLORS



Follow the three (3) steps when specifying Intersection Downlighting:

1. Choose your ceiling system layout

2' x 2' Ceiling layout with lights 4' apart

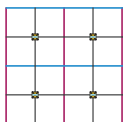

2' x 2' Ceiling layout with lights 6' apart

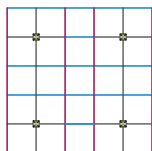

2' x 2' Ceiling layout with lights 8' apart

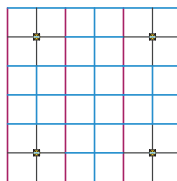

30" x 30" Ceiling layout with lights 5' apart

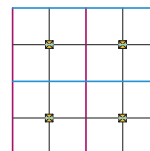

30" x 30" Ceiling layout with lights 7.5' apart

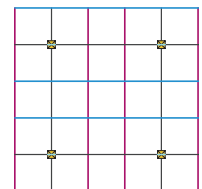

LIGHTING SOLUTIONS

Intersection Downlighting for Acoustical Ceilings

2. Choose your 9/16" Intersection Profile Downlighting Kit (main beams, standard cross tees, wall molding, and lights need to be ordered separately)

Choose Hub Kit, then appropriate cross tee module

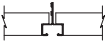
Item No. ♦	Description
Silhouette® XL® 1/4" Reveal 	76D4SK_ _ 4" Downlight Hub Kit w/ Yokes & hardware
	XL7622DL_ _ 24" Module Downlight Cross Tee
	XL7628DL_ _ 30" Module Downlight Cross Tee

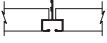
Item No. ♦	Description
Silhouette XL 1/8" Reveal 	768D4SK_ _ 4" Downlight Hub Kit w/ Yokes & hardware
	XL76822DL_ _ 24" Module Downlight Cross Tee
	XL76828DL_ _ 30" Module Downlight Cross Tee

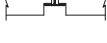
Item No. ♦	Description
Suprafine® XL® 	75D4SK_ _ 4" Downlight Hub Kit w/ Yokes & hardware
	XL7522DL_ _ 24" Module Downlight Cross Tee
	XL7528DL_ _ 30" Module Downlight Cross Tee

Item No. ♦	Description
Interlude® XL® HRC 	61D4SK_ _ 4" Downlight Hub Kit w/ Yokes & hardware
	XL6122DL_ _ 24" Module Downlight Cross Tee
	XL6128DL_ _ 30" Module Downlight Cross Tee

8' Cross tee - Notched 48" O.C. available Made-to-Order

♦ Add the 2-letter color suffix to the item number when specifying or ordering (Example: AX2WEC Z W)

KIT COMPONENTS INCLUDED (8 KITS PER CARTON)

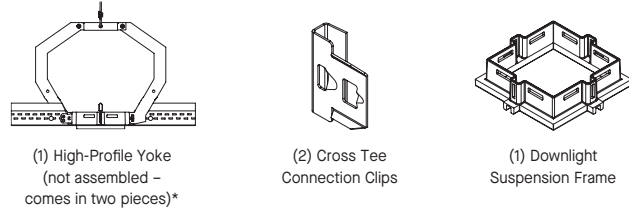

ACCESSORIES

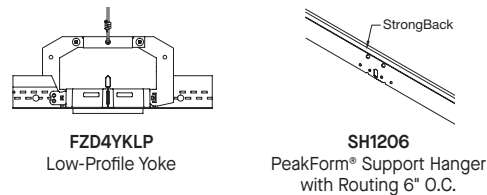

INTERSECTION DOWNLIGHTING ASSEMBLY/CEILING PANEL LAYOUT

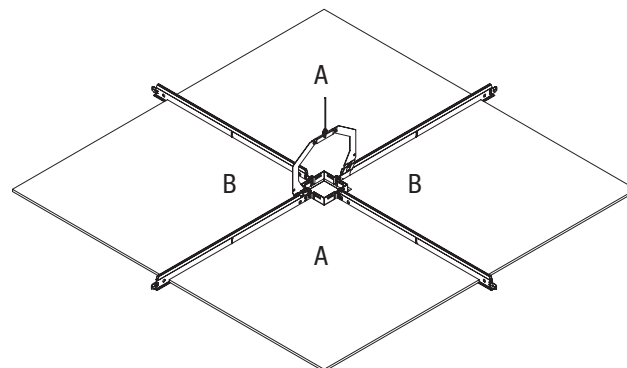
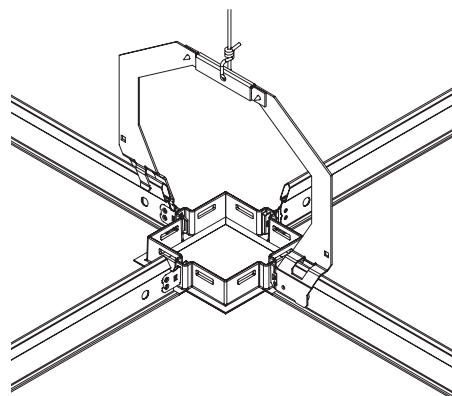



NOTE: These are directional panels and come as (8) pieces per carton (4 As / 4 Bs marked)

LIGHTING SOLUTIONS

Intersection Downlighting for Acoustical Ceilings

3. Choose your Ceiling Panel Notched Calla® and Ultima® ceiling panels (24" x 24" tegular panels for 9/16" grid) also available as a special order.

VISUAL SELECTION

	Edge Profile	Item No.	Dimensions (Inches)
CALLA® Notched Ceiling Panels	9/16" Square Tegular	2818	24 x 24 x 1" 
CALLA® Compatible Full-Size Panels	9/16" Square Tegular	2824	24 x 24 x 1" 

Intersection Downlighting Ceiling Panels/ 1 Notch	9/16" Square Tegular	
	Visual	Size
	Ultima®	24 x 24"
	Ultima High NRC	24 x 24"
	Calla	30 x 30"
	Ultima	30 x 30"
	Ultima High NRC	30 x 30"

PERFORMANCE SELECTION

Dots represent high level of performance.

UL Classified Acoustics	Total Acoustics ¹	Articulation Class	Fire Rating	Light Reflect	Anti-Mold & Mildew	Sag Resist	Certified Low VOC Emissions	Wash	Impact	Scratch	Soil	Recycled Content	Recycle Program	30-Yr Warranty
0.85	35	BEST	Class A	0.86	*	*	*	*	*	*	*	*	*	*
0.85	35	BEST	Class A	0.86	*	*	*	*	*	*	*	*	*	*
N/A	N/A	N/A	N/A	N/A	N/A	N/A	N/A	N/A	N/A	N/A	N/A	N/A	N/A	N/A

¹ Total Acoustics® ceiling panels have an ideal combination of sound absorption and sound blocking in one product. **GOOD** (NRC 0.60-0.65; CAC 35+) **BETTER** (NRC 0.70-0.75; CAC 35+) **BEST** (NRC 0.80+; CAC 35+)
NOTE: Item # 2824 is the compatible full-size (24" x 24" x 1") panel

CONNECT™ FAMILY

The aesthetic and uncompromising craftsmanship of the Connect™ Lighting system integrates beautiful illumination with simplicity.

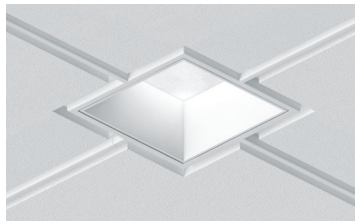

LIGHTING FIXTURES

USAI®

Lighting

For more product information visit: usailighting.com/connect

PHYSICAL DATA

Material

Cross Tees: Hot-dipped galvanized steel
High-Profile Yoke: Galvanized steel
Low-Profile Yoke: Galvanized steel
Cross Tee Connector Clip: Galvanized steel
Downlight Suspension Frame: ADC12 Aluminum

Surface Finish

Baked polyester paint or powder-coated finish

Cross Tee / Downlight Suspension Frame Interface
Flush

End detail

Staked-on XL Clip

Installation Considerations

The high-profile yoke included in each kit is designed for use with the USAI Lighting CONNECT Family Downlight, Adjustable, and Wall Wash lighting options.

For low plenum installations, the low-profile yoke can be ordered separately and comes with (8) eight unassembled yokes. The low-profile yoke can be used with the USAI CONNECT Family Downlight and Wall Wash options. A low-profile yoke will not fit the housing of a USAI CONNECT adjustable downlight and a high-profile yoke must be used.

Downlight Suspension Frame can only receive directional cross tees. For light spacing 6' apart alternate main beam spacing (4' spacing, 2' spacing).

Downlight Hub Kit Components

Each carton contains (8) eight Intersection Downlighting Kits with the following components:

- (8) High-Profile Yokes (unassembled)
- (8) Downlight Suspension Frames
- (20) Cross Tee Connection Clips (16 clips are required, 4 extra per carton)

Module Cross Tee Kits
(32) cross tees per carton

Warranty
10-year limited warranty