

# TECTUM® DesignArt™ – Lines Finale™ PB

with Plant-based Binder Infill  
Direct-Attach Wall Panels  
coarse texture



**SUSTAIN®**  
High Performance  
Sustainable  
Ceiling Systems



CAD/Revit® drawings at:  
[armstrongceilings.com/cadrevit](http://armstrongceilings.com/cadrevit)

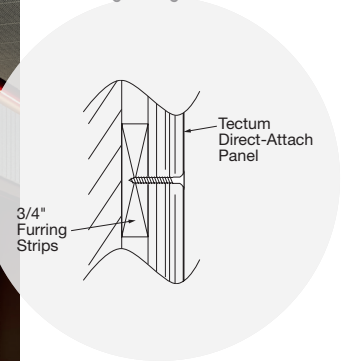

Visit our online pattern gallery at:  
[armstrongceilings.com/patterngallery](http://armstrongceilings.com/patterngallery)

Mix and match Shapes and  
Lines for a truly unique visual!



Tectum DesignArt - Lines Finale PB Rings, Arcs, Bands ceiling and wall panels in Polar, Marigold, Feldspar, and Mist

[armstrongceilings.com/designart](http://armstrongceilings.com/designart)

Integrated furring strips and an acoustical infill reduce installation time and offer excellent sound absorption with one-of-a-kind visuals.

## KEY SELECTION ATTRIBUTES

- Tectum® DesignArt™ - Lines Finale™ PB panels have UL® Certified acoustics with acoustical testing and reporting that align with industry-wide best practices
- Excellent sound absorption – NRC 0.85 (1" panel, D-20 mounting)
- Panels are manufactured with a plant-based binder infill and furring pieces to provide maximum sound control and install 2.5x faster than Direct-Attach for the same acoustic performance
- 29 standard routed panels for 24" × 24" and 24" × 48" Direct-Attach ceilings are available in 24 nature-inspired colors and Natural
- Products in the Tectum DesignArt portfolio are made to work together
- Precision routing of lines allows for seamless connections between compatible panel face designs
- Great retrofit solution for noise reduction
- CleanAssure™ family of products – includes disinfectable panels, suspension systems, and trim (standard colors only)
- Part of the Sustain® portfolio, and meeting the most stringent industry sustainability compliance standards today
- All panel edges and furring strips are painted; top face panel features beveled edges
- Variety of made-to-order color options available
- Touch up paint available for the 24 standard colors
- Available for ceiling applications
- Panels can be mechanically fastened to a wide variety of surfaces including masonry, drywall, drywall grid system, wood, and more
- USDA Biobased content: 98%

## DETAILS



1. Panel face with beveled and painted edges
2. Back of panel with factory-applied furring strips and acoustical infill

TECTUM® DesignArt™ –  
Lines Finale™ PB  
with Plant-based Binder Infill  
Direct-Attach Wall Panels  
coarse texture



energy management	construction waste mgmt.	regional materials	design for flexibility	EPD	recyclables/extended producer resp.	biobased materials	FSC® (for wood)	recycled content	sourcing of raw materials	material ingredient reporting	low emitting materials	lighting quality	acoustics

LOCATION DEPENDENT

For LEED contribution contact TechLine

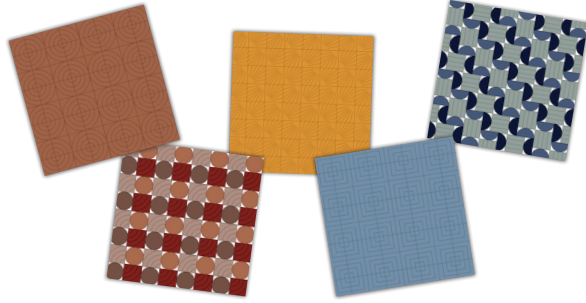

Visit our online pattern gallery at [armstrongceilings.com/patterngallery](http://armstrongceilings.com/patterngallery)  
Use our recommended colors, or choose from 24 standard colors, in addition to Natural to create your own one-of-a-kind pattern!

**COLORS** Due to printing limitations, shade may vary from actual product.

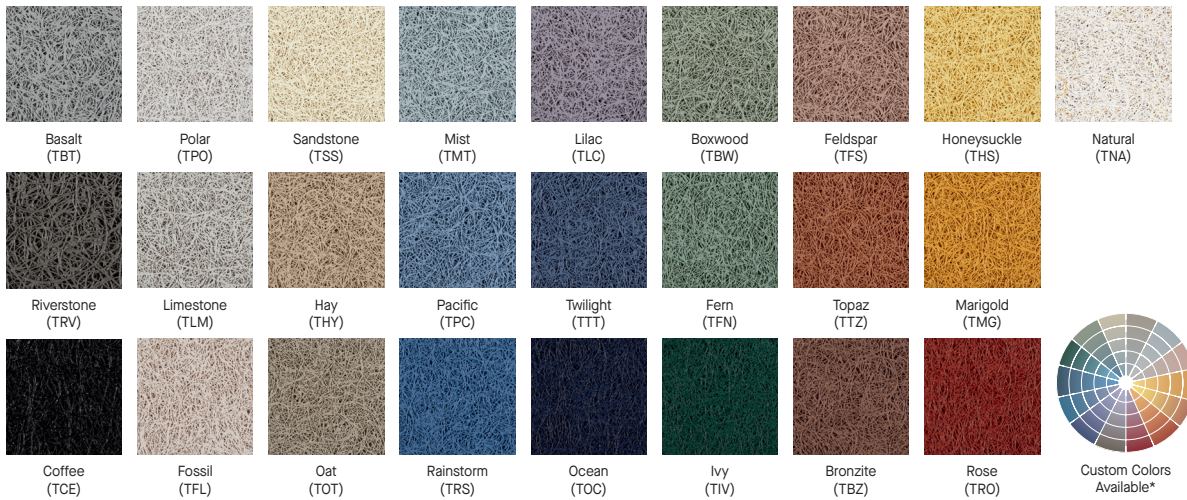

\* For custom options contact ASQuote, ASQuote@armstrongceilings.com  
Custom color panels and any panels greater than 1" thick are not included in Sustain® portfolio.

**VISUAL SELECTION**

Item No.	Dimensions W x L x H (Inches)
TECTUM® DesignArt™ – Lines Finale™ PB Long Edges Beveled/ Short Edges Beveled	24 × 24 × 1" <input type="checkbox"/>
	24 × 48 × 1" <input type="checkbox"/>

**PERFORMANCE** Dots represent high level of performance.

Fire Rating	Bio-Block	Humi-Guard+	CleanAssure™ Disinfectable Panels	DURABILITY	30-Yr Warranty
Anti-Mold/Mildew	Sag Resist	Certified Low VOC Emissions	Fog	Impact	
Class A	*	*	*	*	*

**ACOUSTICAL INFORMATION**

Panel Thickness	UL® Classified Acoustics	Mounting Method
1" with plant-based binder infill & 1" furring	0.80 *	A
	0.85 *	D-20



# TECTUM® DesignArt™ – Lines Finale™ PB

with Plant-based Binder Infill  
Direct-Attach Wall Panels  
coarse texture

## FACE PROFILES



Currents  
6383D11T10



Rings  
6383D04T10

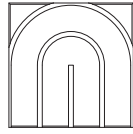

Arcs  
6383D03T10

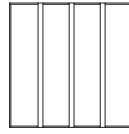

Bands  
6383D08T10

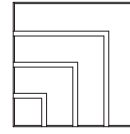

Steps  
6383D07T10

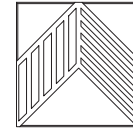

Illusions  
6383D09T10

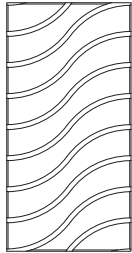

Currents B  
6383D49T10

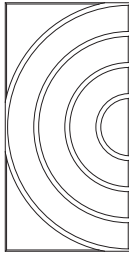

Rings B  
6383D45T10

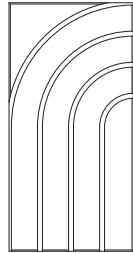

Retro  
6383D43T10

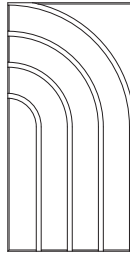

Retro B  
6383D44T10

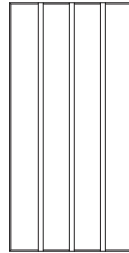

Bands B  
6383D46T10



Bands C  
6383D47T10

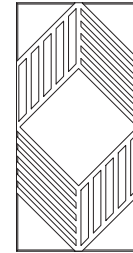

Illusions B  
6383D48T10

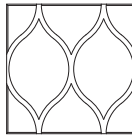

Droplets  
6383D13T10

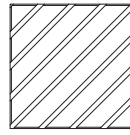

Tilts  
6383D15T10

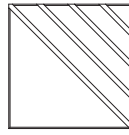

Decos  
6383D10T10

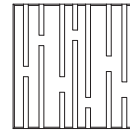

Signals  
6383D14T10

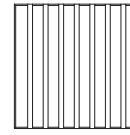

Strings  
6383D12T10

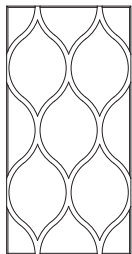

Droplets B  
6383D51T10

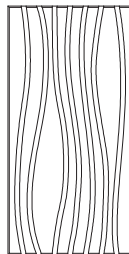

Contours  
6383D53T10

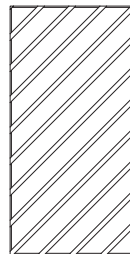

Tilts B  
6383D40T10

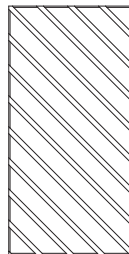

Tilts C  
6383D41T10

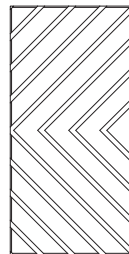

Tilts D  
6383D42T10

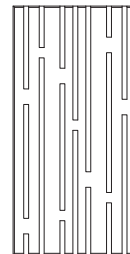

Signals B  
6383D52T10

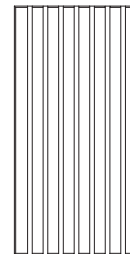

Strings B  
6383D50T10

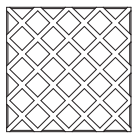

Hatches  
6383D01T10

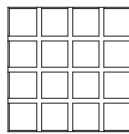

Checkers  
6383D06T10

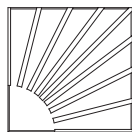

Rays  
6383D05T10

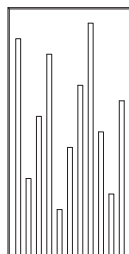

Levels  
6383D54T10

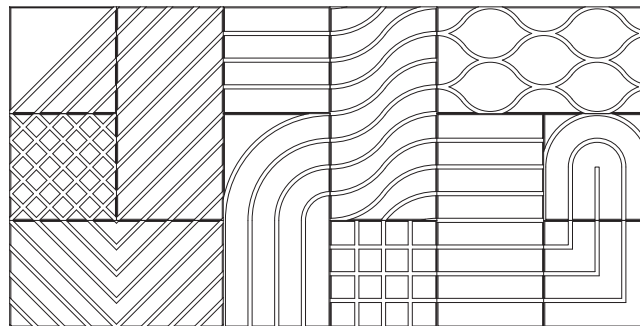

Precision Routing Allows for Mixing and Matching

◆ When specifying or ordering, include the appropriate 3-digit color suffix TNA = Natural; TPO = Polar (e.g. 6383D54T10 I P Q).

TechLine 877 276-7876

armstrongceilings.com/designart

**Armstrong®**  
World Industries



PARTITIONS & WALLS



# TECTUM® DesignArt™ – Lines Finale™ PB

with Plant-based Binder Infill  
Direct-Attach Wall Panels  
coarse texture

## SYSTEM INSTALLATION DETAILS

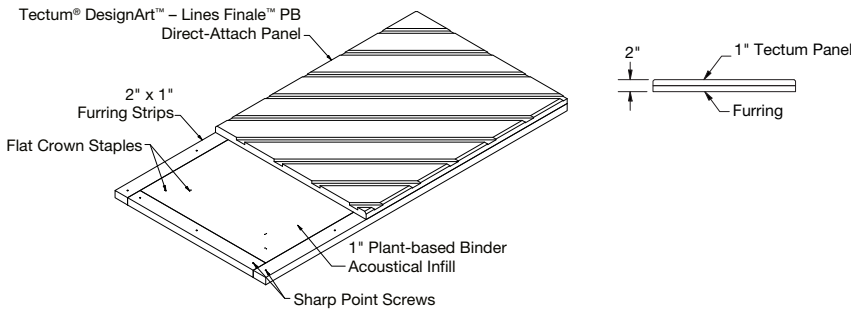

1 Panel Construction

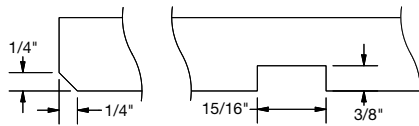

2 Routing for Lines with Beveled Edge

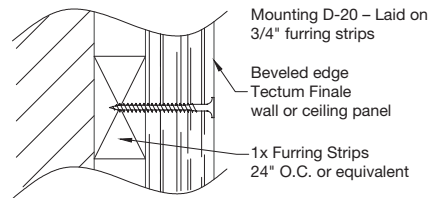

3 Acoustical Mounting Methods

## ACCESSORIES

Item No. ♦	Description	Quantity
5456GAL1 _ _ _	Touch up paint	1 gallon
8187L30TWH†	#8 x 3" Painted Head – Sharp point Screws	1000/CTN
8188L30TWH†	#8 x 3" Painted Head – Drill point Screws	1000/CTN
8189L32TWH	3-1/4" Painted Head – CMU Screws	500/CTN

♦ When specifying or ordering, include the appropriate 3-digit color suffix TNA = Natural; TPO = Polar (e.g. 5456GAL1 T P O). Consult installation instructions for fastener guidance.

† Touch up paint is available to paint screw heads in field if desired or specified.

NOTE: Projects may require alternative screw lengths and types depending on site conditions. Please consult installation instructions for guidance.

## PHYSICAL DATA

### Material

Cementitious wood fiber panels with a fiberglass plant-based binder infill.; FSC® certified. For more information about FSC-certified fire-retardant products, or to view our FSC-certification letter, contact TechLine at 1 877 276-7876.

### Surface Finish

Factory-applied latex paint on abuse-resistant silicate surface coating. Natural finish is unpainted but, after coating is applied, panels may appear light in color.

Panels are painted on the edge, however due to fibrous texture of panels, certain angles and lighting conditions will make edge appear less or more painted.

Can be field painted up to 6 times without impacting acoustic or fire performance. See installation instructions for details on paint and application method.

### Fire Performance

Class A. Flame Spread Index 25 or less and Smoke Developed Index 50 or less when tested in accordance with ASTM E84.

CAN/ULC S102 surface burning characteristics. Flame Spread Index of 25 or less and Smoke Developed Index of 50 or less (painted, face only).

### VOC Emissions

Third-party certified compliant with California Department of Public Health CDPH/EHLB/Standard Method Version 1.2, 2017. This standard is the guideline for low emissions in LEED®, WELL Building Standard®, CalGreen Title 24, ANSI/ASHRAE/USGBC/IES Standard 189; ANSI/GBI Green Building Assessment Protocol.

### Humidity/Sag Resistance

HumiGuard® Plus performance panels are recommended for areas subject to high humidity, up to, but not including, standing water and outdoor applications.

### Anti-Mold/Mildew

Panels with BioBlock® performance resist the growth of mold and mildew on the panel surface.

### Installation Considerations

Panels must be mechanically attached to approved substrate per installation instructions. Acoustical performance varies by mounting method; panels must be installed as directed to achieve published NRC values.

Use caution and wear appropriate hand, eye, and dust mask protection when cutting and installing Tectum ceiling panels. Refer to installation instructions for complete details and cutting recommendations.

### Primary (Embodied) Energy

See all LCA information on our EPDs.

### Design Considerations

Color variation among panels is common due to the natural characteristics of the wood on all painted and Natural panels.

Wood fibers may appear orange on natural-colored panels due to the characteristics of the wood.

Physical product samples for standard and custom colors are available upon request. Please refer to the physical product sample prior to making a final selection. While we strive to ensure exact color matches, various factors such as differences in materials, texture, substrate porosity, painting processes, lighting, and observer subjectivity can all affect how paint colors appear on ceiling and wall panels, suspension systems, and trim products. Due to these and other differences, ceiling and wall panels, trim products, and suspension systems with the same color name will coordinate but may not be an exact color match. Product is dyelotted. Order sufficient initial quantities and attic stock to minimize possible color variation.

### Cleaning and Disinfecting

Cleaning and CDC-approved disinfecting options available on [armstrongceilings.com/cleaning](http://armstrongceilings.com/cleaning)

### Warranty

30-Year Warranty. Details at [armstrongceilings.com/warranty](http://armstrongceilings.com/warranty)

### Weights and Sold By

1" – 3.1 LBS/SF

Panels sold by the piece. Other accessory elements quantities noted above.

