

TECTUM® DesignArt™ – Shapes

Direct-Attach Wall Panels
coarse texture



SUSTAIN®
High Performance
Sustainable
Ceiling Systems



CAD/Revit® drawings at:
armstrongceilings.com/cadrevit

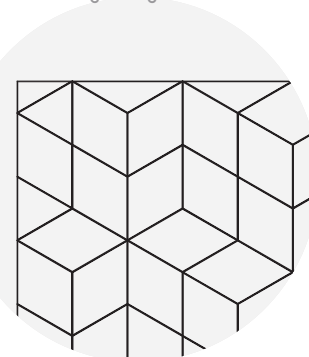

Visit our online pattern gallery at:
armstrongceilings.com/patterngallery

Mix and match Shapes and
Lines for a truly unique visual!

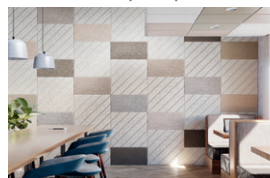

Tectum DesignArt - Shapes Direct-Attach wall panels in pattern TDSH-0006 in standard colors

armstrongceilings.com/designart

Transform interior spaces by combining texture, shapes, patterns, and colors with sustainable, acoustical Tectum® DesignArt™ – Shapes Direct-Attach Wall Panels.

KEY SELECTION ATTRIBUTES

- 30 standard Shapes direct-attach wall panels available in 24 new standard colors, and Natural
- Products in the Tectum DesignArt portfolio are made to work together
- Available for ceiling and wall applications
- Tectum DesignArt – Shapes panels have UL® Certified acoustics with testing and reporting that align with industry-wide best practices
- Great retrofit solution for noise reduction
- Excellent sound absorption – NRC up to 0.85 (1" panel, C-40 Mounting)
- CleanAssure™ family of products – includes disinfectable panels, suspension systems, and trim (standard colors only)
- Sustainable Beyond Standard: Custom sizes in 1" thickness and all standard panels are part of the Sustain® portfolio, and meet the most stringent industry sustainability compliance standards today
- All edges are beveled and painted
- Touch up paint for standard colors available

- Panels can be mechanically fastened to a wide variety of surfaces including masonry, drywall, drywall grid system, wood, and more
- USDA Biobased content: 98%

COLORS Due to printing limitations, shade may vary from actual product.

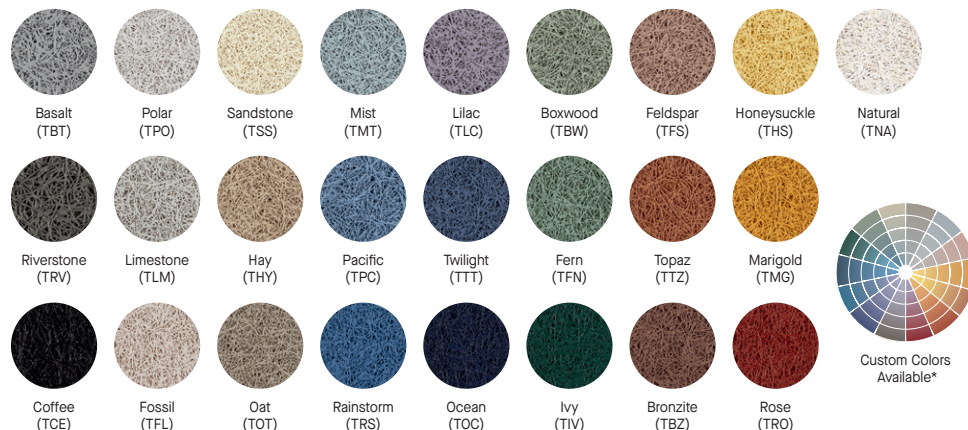

DETAIL

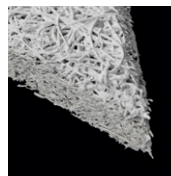

Tectum DesignArt - Shapes Direct-Attach panel in Polar. Edges are beveled and painted

* Colors that are pre-qualified to meet Sustain portfolio requirements are available upon request. Other made-to-order colors must be evaluated if sustainability criteria is required. Lead time will increase.

TECTUM® DesignArt™ – Shapes

Direct-Attach Wall Panels
coarse texture



energy management	construction waste mgmt.	regional materials	design for flexibility	EPD	recyclable/extended producer resp.	biobased materials	FSC® (for wood)	recycled content	sourcing of raw materials	material ingredient reporting	low emitting materials	lighting quality	acoustics
✓	✓	✓	✓	✓	✓	✓	✓	✓	✓	✓	✓	✓	✓

For LEED contribution contact TechLine

Well Building Standard™ (WELL) Living Building Challenge® (LBC)

VISUAL SELECTION

Item No.	Dimensions W x L x H (Inches)
TECTUM® DesignArt™ – Shapes Beveled Edges	See below



PERFORMANCE

Dots represent high level of performance.

Fire Rating	Anti-Mold/Mildew	Sag Resist	Certified Low VOC Emissions	CleanAssure™ Disinfectable Panels	Fog	Impact	Scratch	30-Yr Warranty
Class A	*	*	*	*	*	*	*	*

ACOUSTICAL INFORMATION

Panel Thickness	UL Classified Acoustics NRC	Mounting Method
1"	0.40	A
	0.45	D-20
	0.80	C-20
	0.85	C-40

30° SHAPES

Isosceles Triangles
Nominal Dimensions

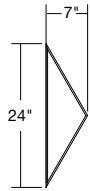

Item No.	Description
5420T11T10 ___	Isosceles Triangle

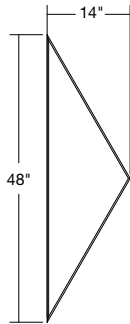

Item No.	Description
5420T12T10 ___	Isosceles Triangle

45° SHAPES

Right Triangles
Nominal Dimensions

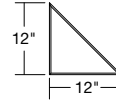

Item No.	Description
5420T01T10 ___	Right Triangle

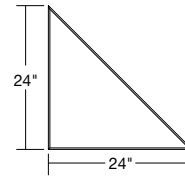

Item No.	Description
5420T02T10 ___	Right Triangle

Parallelograms
Nominal Dimensions

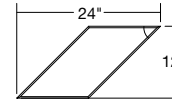

Item No.	Description
5420P01T10 ___	Right Parallelogram

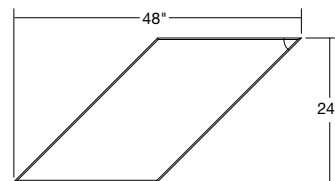

Item No.	Description
5420P02T10 ___	Right Parallelogram

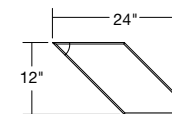

Item No.	Description
5420P03T10 ___	Left Parallelogram

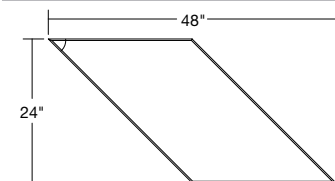

Item No.	Description
5420P04T10 ___	Left Parallelogram

◆ When specifying or ordering, include the appropriate 3-digit color suffix TNA = Natural; TPO = Polar (e.g. 5420R01T10 I P Q). Consult installation instructions for fastener guidance.



MORE ITEMS ▶

TECTUM® DesignArt™ – Shapes

Direct-Attach Wall Panels
coarse texture

60° SHAPES

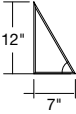
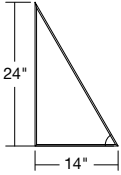
Right Triangles

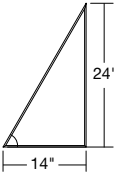
Nominal Dimensions	Item No. ♦	Description
	5420T05T10 ___	Right Triangle – Right
	5420T06T10 ___	Right Triangle – Right
	5420T07T10 ___	Right Triangle – Left
	5420T08T10 ___	Right Triangle – Left

Parallelograms

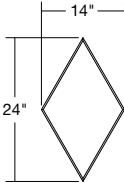
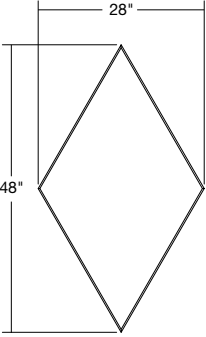
Nominal Dimensions	Item No. ♦	Description
	5420P05T10 ___	Parallelogram
	5420P06T10 ___	Parallelogram

60° SHAPES

Hexagons

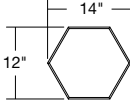
Nominal Dimensions	Item No. ♦	Description
	5420H01T10 ___	Hexagon
	5420H02T10 ___	Hexagon

Trapezoids

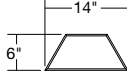
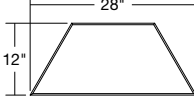
Nominal Dimensions	Item No. ♦	Description
	5420Z01T10 ___	Trapezoid
	5420Z02T10 ___	Trapezoid

Equilateral Triangles

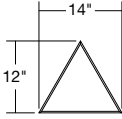
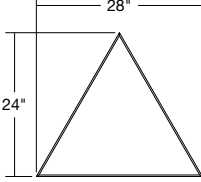
Nominal Dimensions	Item No. ♦	Description
	5420T03T10 ___	Equilateral Triangle
	5420T04T10 ___	Equilateral Triangle

♦ When specifying or ordering, include the appropriate 3-digit color suffix TNA = Natural; TPO = Polar (e.g. 5420R01T10 I.P.Q.). Consult installation instructions for fastener guidance.

MORE ITEMS ▶

TECTUM® DesignArt™ – Shapes

Direct-Attach Wall Panels
coarse texture

90° SHAPES

Squares & Rectangles

Nominal Dimensions

Item No. ♦ Description

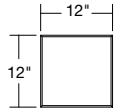

542OR01T10 ___ Square

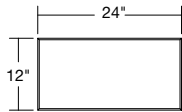

542OR02T10 ___ Rectangle

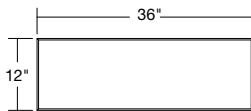

542OR03T10 ___ Rectangle

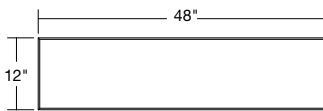

542OR04T10 ___ Rectangle

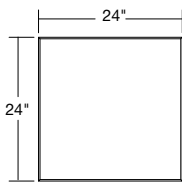

542OR05T10 ___ Square

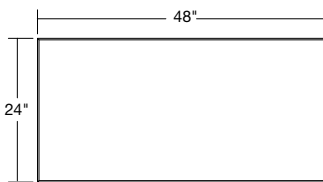

542OR06T10 ___ Rectangle

360° SHAPES

Circles

Nominal Dimensions

Item No. ♦ Description

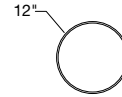

542OC01T10 ___ Circle

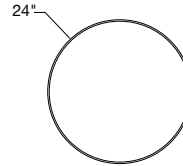

542OC02T10 ___ Circle

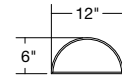

542OC03T10 ___ Semicircle

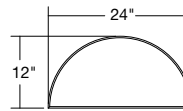

542OC04T10 ___ Semicircle

♦ When specifying or ordering, include the appropriate 3-digit color suffix TNA = Natural; TPO = Polar (e.g. 542OR01T10 I P Q). Consult installation instructions for fastener guidance.



PARTITIONS & WALLS

TECTUM® DesignArt™ – Shapes

Direct-Attach Wall Panels
coarse texture

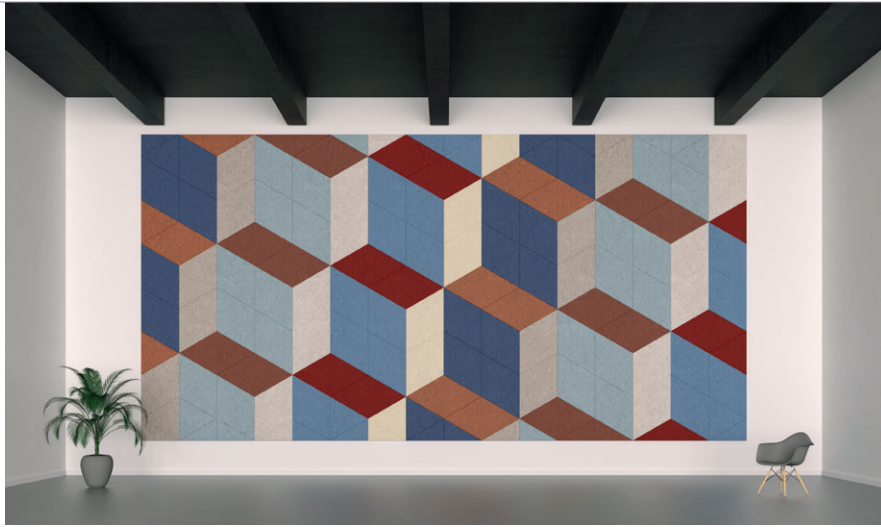

Tectum® DesignArt™ – Shapes, pattern TDSH-0006

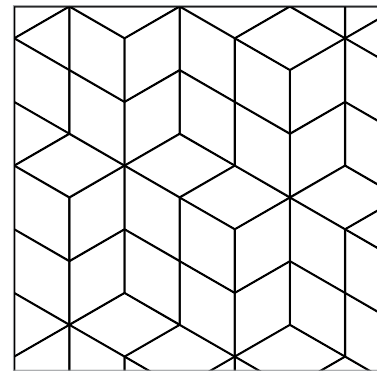
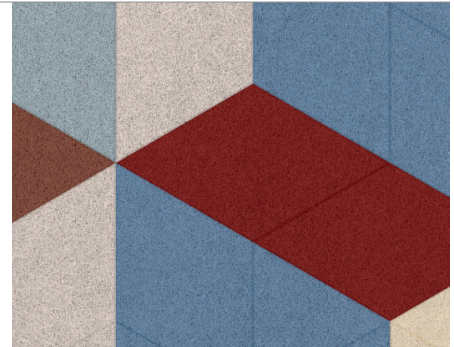

Tectum DesignArt – Shapes, pattern TDSH-0006

Visit our online pattern gallery at armstrongceilings.com/patterngallery
Use our recommended colors, or choose from 24 standard colors, in addition to Natural to create your own one-of-a-kind pattern!



Tectum DesignArt – Shapes, pattern TDSH-0001



Tectum DesignArt - Shapes, pattern TDSH-0004



Tectum DesignArt - Shapes, pattern TDSH-0009

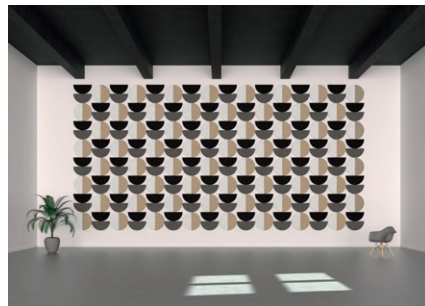

Tectum DesignArt - Shapes, pattern TDSH-0011

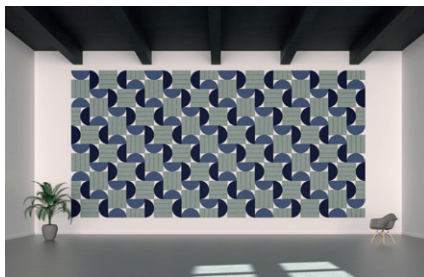

Tectum DesignArt – Lines and Tectum DesignArt – Shapes, pattern TDSL-0001

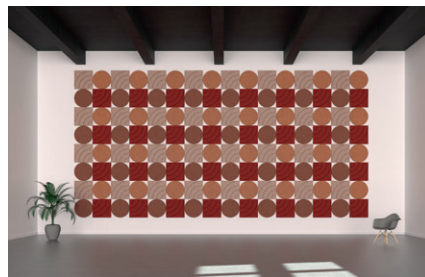

Tectum DesignArt – Lines and Tectum DesignArt – Shapes, pattern TDSL-0002



PARTITIONS & WALLS

TechLine 877 276-7876
armstrongceilings.com/designart

Armstrong®
World Industries

TECTUM® DesignArt™ – Shapes

Direct-Attach Wall Panels
coarse texture

ACCESSORIES

Item No. ♦	Description	Quantity
5456GAL1 _ _ _	Touch up paint	1 gallon
8187L16TWH†	#6 × 1-5/8" Painted Head – Sharp point Screws	1000/ctn
8188L16TWH†	#6 × 1-5/8" Painted Head – Drill point Screws	1000/ctn
8189L22TWH	2-1/4" Painted Head – CMU Screws	500/ctn
8189L22TNA	2-1/4" Painted Head – CMU Screws	500/ctn

♦ When specifying or ordering, include the appropriate 3-digit color suffix TNA = Natural; TPO = Polar (e.g. 5456GAL1 I P Q). Consult installation instructions for fastener guidance.

† Touch up paint is available to paint screw heads in field if desired or specified.

NOTE: Projects may require alternative screw lengths and types depending on site conditions. Please consult installation instructions for guidance.

FURRING STRIP LAYOUT

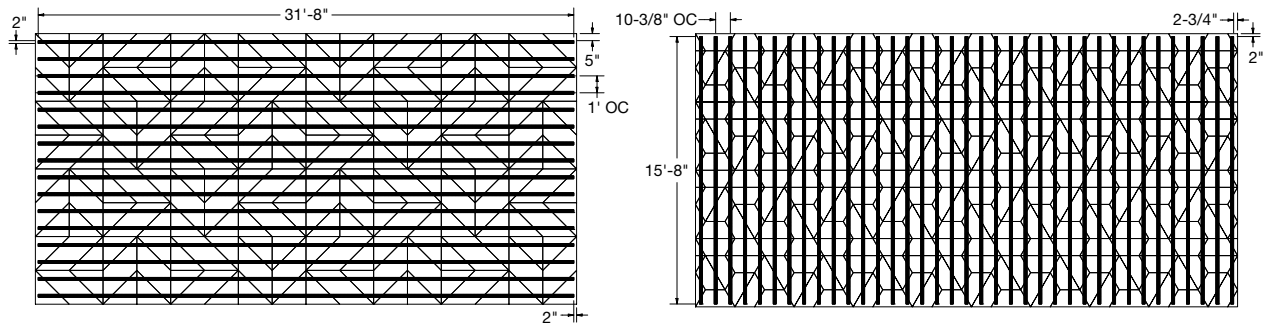

Furring strip spacing will vary depending on the scale of the shapes. Furring strip layouts are included on the Bill of Materials in our online pattern gallery at armstrongceilings.com/patterngallery.

ACOUSTICAL MOUNTING METHODS

Mounting A

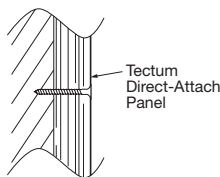

Mounting D-20

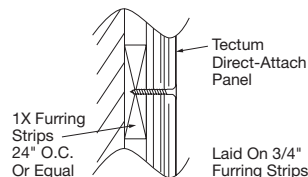

Mounting C-20

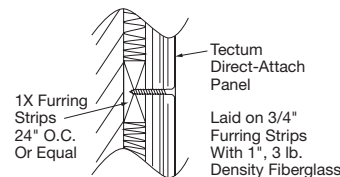

Mounting C-40

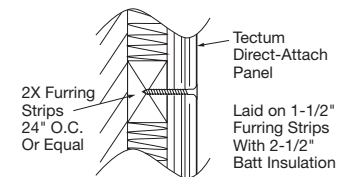

Patterns can be installed with adjacent panel edges touching, or with negative space between panels where the walls substrate is visible. Furring installation enhances acoustics, but is not recommended for discontinuous patterns, such as those with a circle shape.

PHYSICAL DATA

Material

Cementitious Wood Fiber; FSC® certified. For more information about FSC certified fire-retardant products, or to view our FSC-certification letter, contact TechLine at 1 877 276-7876.

Surface Finish

Factory-applied latex paint on abuse-resistant silicate surface coating. Natural finish is unpainted but, after coating is applied, panels may appear light in color.

Panels are painted on the edge, however due to fibrous texture of panels, certain angles and lighting conditions will make edge appear less or more painted.

Can be field painted up to 6 times without impacting acoustic or fire performance. See installation instructions for details on paint and application method.

Fire Performance

Class A. Flame Spread Index 25 or less and Smoke Developed Index 50 or less when tested in accordance with ASTM E84.

CAN/ULC S102 surface burning characteristics. Flame Spread Index of 25 or less and Smoke Developed Index of 50 or less (painted, face only).

VOC Emissions

Third-party certified compliant with California Department of Public Health CDPH/EHLB/Standard Method Version 1.2, 2017. This standard is the guideline for low emissions in LEED®, WELL Building Standard®, CalGreen Title 24, ANSI/ASHRAE/USGBC/IES Standard 189; ANSI/GBI Green Building Assessment Protocol.

Humidity/Sag Resistance

HumiGuard® Plus performance panels are recommended for areas subject to high humidity, up to, but not including, standing water and outdoor applications.

Anti-Mold/Mildew

Ceiling panels with BioBlock® performance resist the growth of mold and mildew on the panel surface.

Installation Considerations

Panels must be mechanically attached to approved substrate per installation instructions.

Use caution and wear appropriate hand, eye, and dust mask protection when cutting and installing Tectum panels. Refer to installation instructions for complete details and cutting recommendations.

Primary (Embodied) Energy

See all LCA information on our EPDs.

Design Considerations

Color variation among panels is common due to the natural characteristics of the wood on White and Natural panels.

Wood fibers may appear orange on natural-colored panels due to the characteristics of the wood.

Physical product samples for standard and custom colors are available upon request. Please refer to the physical product sample prior to making a final selection. While we strive to ensure exact color matches, various factors such as differences in materials, texture, substrate porosity, painting processes, lighting, and observer subjectivity can all affect how paint colors appear on ceiling and wall panels, suspension systems, and trim products. Due to these and other differences, ceiling and wall panels, trim products, and suspension systems with the same color name will coordinate but may not be an exact color match. Product is dye-lotted. Order sufficient initial quantities and attic stock to minimize possible color variation.

Seismic Restraint

Tectum Direct-Attach wall panels are approved for application in all seismic areas when installed per the seismic guidelines in the Armstrong Ceiling and Wall Installation Instructions.

Cleaning and Disinfecting

Cleaning and CDC-approved disinfecting options available on armstrongceilings.com/cleaning

Warranty

30-Year Warranty. Details at armstrongceilings.com/warranty

Weights and Sold By

1' – 1.65 lbs/SF

Panels sold by the piece. Other accessory elements quantities noted above.

TechLine / 1 877 276-7876
armstrongceilings.com/designart

BPCS-6638-322

LEED® is a registered trademark of the U.S. Green Building Council; Declare® and Living Building Challenge® (LBC) are registered trademarks of the International Living Future Institute; WELL™ and WELL Building Standard™ are trademarks of the International WELL Building Institute; FSC® is a registered trademark of FSC Forest Stewardship Council, A.C., license code FSC-C007626; Revit® is a registered trademark of Autodesk, Inc.; UL and UL Certified are registered trademarks of UL LLC; all other trademarks used herein are the property of AWI Licensing LLC and/or its affiliates © 2023 AWI Licensing LLC

Armstrong®
World Industries



PARTITIONS & WALLS