

WOODWORKS® Grille – Classics

Solid Wood Ceiling Panels
Backer, Dowel, and Backer & Dowel Combination

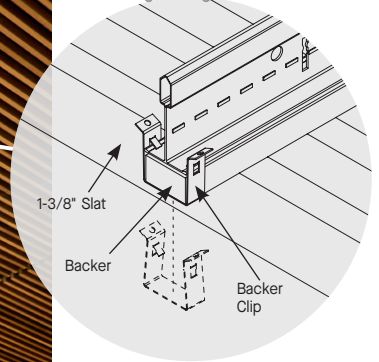



CAD/Revit® drawings at:
armstrongceilings.com/cadrevit



WoodWorks Grille – Classics Custom Installation – in Dark Cherry

These warm, natural wood ceilings offer installation flexibility and a variety of design options.

KEY SELECTION ATTRIBUTES

-  10 new standard finishes on solid poplar are tinted to replicate naturally occurring wood tones
-  Panels are part of the Sustain® portfolio and meet the most stringent industry sustainability compliance standards today
-  Coordinating solid wood trims in 4" and 6" depths
- The natural warmth of wood can contribute to biophilic designs and building certification standards like the WELL™ v2 "Nature and Place" feature
- Select products included in the FAST134 program – ready to ship in 4 weeks or less
- Installation with dowel or flat backer, or backer and dowel combination
- Integrated downlighting solutions from USAI® Lighting sit perfectly flush with the panel face for a sleek visual
- Integrate linear lights seamlessly with the Integrated Light Connection Clip and lights from Backlight® srl and XAL®
- Lighting solutions are certified for fit and finish and engineered to be supported by standard Armstrong suspension systems for use in all areas, including seismic D, E, F zones
- CleanAssure™ family of products – includes disinfectable panels, suspension systems, and trim
- Custom slat sizes and finishes available for every project
- Install in the ceiling, on the wall, or create ceiling-to-wall transitions
- FSC® certified wood options available as a premium quoted option

Now, Lighting Integration Made Easy



DOWNLIGHTING: WoodWorks Grille – Classics panel with USAI® Micro™ downlight fixture. Integration details at armstrongceilings.com/downlighting

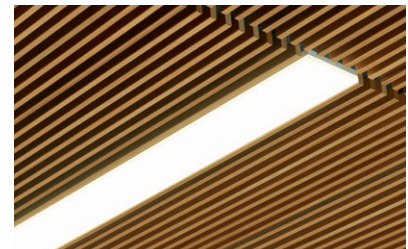

LINEAR LIGHTING: WoodWorks Grille – Classics panels in Maple with 5-1/4" x 95" linear light fixture. Integration details at armstrongceilings.com/linearlighing

WOODWORKS® Grille – Classics

Solid Wood Ceiling Panels Backer, Dowel, and Backer & Dowel Combination



LEED WELL | LBC

energy management	construction waste mgmt.	regional materials	design for flexibility	EPD	recyclables/extended producer resp.	biobased materials	FSC® (for wood)	recycled content	sourcing of raw materials	material ingredient reporting	low emitting/ materials	lighting quality	acoustics
LOCATION DEPENDENT				PREMIUM OPTION				WITH INFILL PANEL					

For LEED contribution contact TechLine

FINISH RANGES ON SOLID POPLAR

Our tinted finishes allow the natural character of the poplar to shine through. The images here reflect the visual range that is likely within our product. Installers will want to lay out panels before installing to achieve preferred aesthetic.

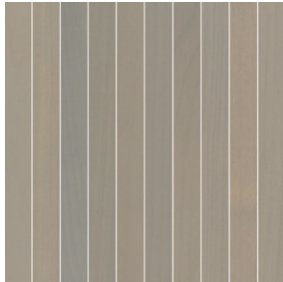

Bleached Grey (GBG)

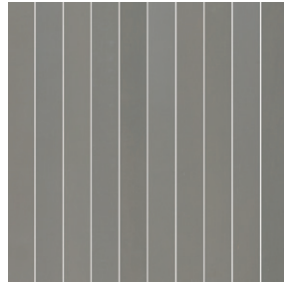

Classic Grey (GCG)



Carbon Grey (GCB)



Rich Mahogany (GRY)



Antique Oak (GAO)



Red Oak (GRK)



English Chestnut (GEC)



Golden Maple (GGM)



Natural Walnut (GWN)



Warm Oak (GWO)



Forest Walnut (GFW)

CUSTOM FINISHES

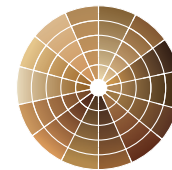

Custom Wood Species and Finishes Available

Panel backers are black. Made-to-order, custom backer colors available.

LEGACY FINISHES



Maple (GMP)



Light Cherry (GLC)



Dark Cherry (GDC)

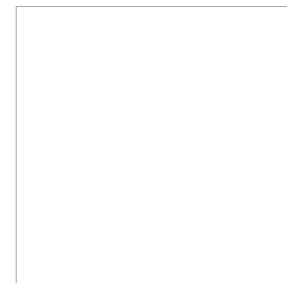

White (GWH)*

Due to printing limitations, shade may vary from actual product.
* Painted White finish is not included in the Sustain® portfolio.





WOODWORKS® – Standard

WOODWORKS® Grille – Classics

Solid Wood Ceiling Panels
Backer, Dowel, and Backer & Dowel Combination

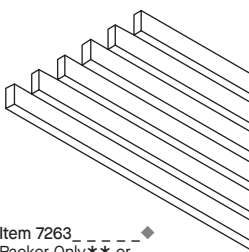
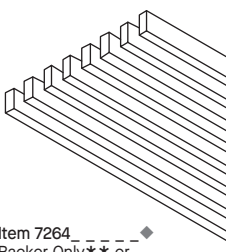
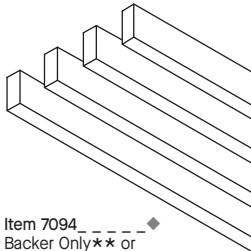
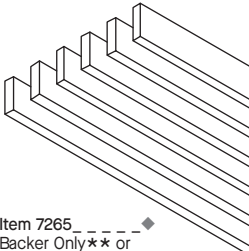
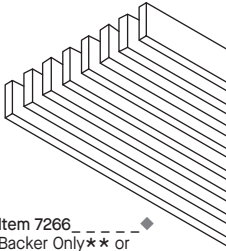
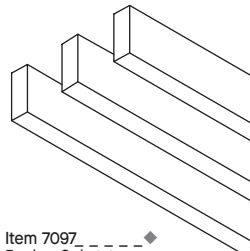
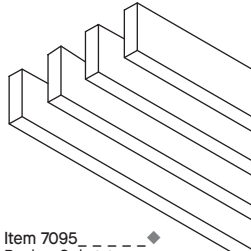
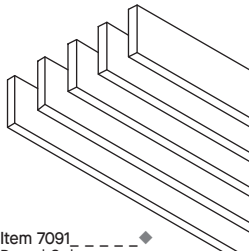
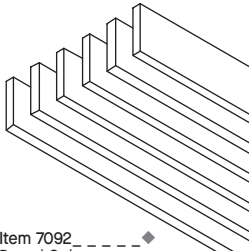
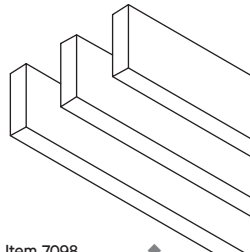
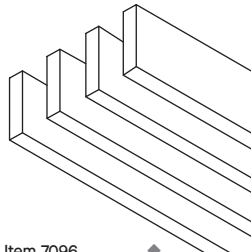
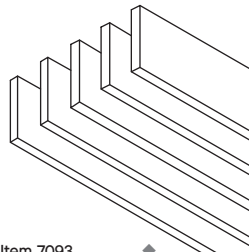
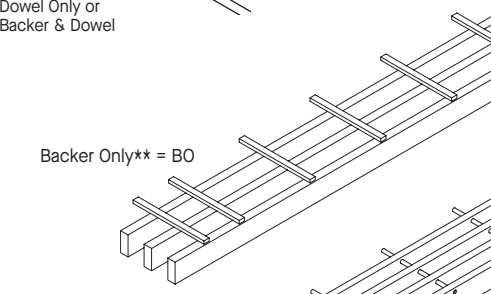
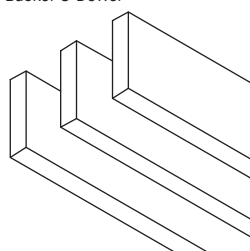
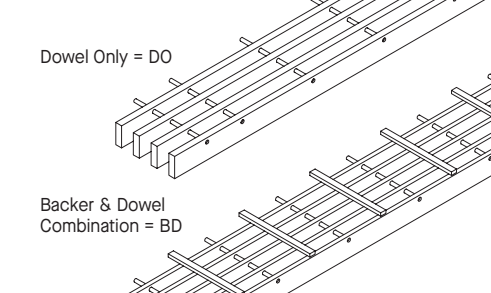
STANDARD PANEL CONFIGURATIONS

	1-1/4" SLAT WIDTH	1" SLAT WIDTH	5/8" SLAT WIDTH		
	3 Slats Per Panel	4 Slats Per Panel	5 Slats Per Panel	6 Slats Per Panel	8 Slats Per Panel
1-3/8" SLAT HEIGHT*				 <p>Item 7263 Backer Only** or Dowel Only</p>	 <p>Item 7264 Backer Only** or Dowel Only</p>
2-1/4" SLAT HEIGHT*		 <p>Item 7094 Backer Only** or Dowel Only</p>		 <p>Item 7265 Backer Only** or Dowel Only</p>	 <p>Item 7266 Backer Only** or Dowel Only</p>
3-1/4" SLAT HEIGHT	 <p>Item 7097 Backer Only** or Dowel Only</p>	 <p>Item 7095 Backer Only** or Dowel Only</p>	 <p>Item 7091 Dowel Only or Backer & Dowel</p>	 <p>Item 7092 Dowel Only or Backer & Dowel</p>	
4-1/4" SLAT HEIGHT	 <p>Item 7098 Dowel Only or Backer & Dowel</p>	 <p>Item 7096 Dowel Only or Backer & Dowel</p>	 <p>Item 7093 Dowel Only or Backer & Dowel</p>	 <p>Backer Only** = BO</p>	
5-1/4" SLAT HEIGHT	 <p>Item 7099 Dowel Only or Backer & Dowel</p>			 <p>Dowel Only = DO</p>	
				 <p>Backer & Dowel Combination = BD</p>	

◆ When specifying or ordering please include the installation type and color suffixes (e.g., 7092 B D G L C – 6 slats 3-1/4" Backer & Dowel in Light Cherry).
* Panel configurations with slats less than 2-1/4" tall are approved for use on walls.
** Backer Only panels are compatible with Integrated Light Connection Clip.

WOODWORKS® – Standard



WOODWORKS® Grille – Classics

Solid Wood Ceiling Panels Backer, Dowel, and Backer & Dowel Combination



Declare.



For LEED contribution contact TechLine

construction waste mgmt.	regional materials	design for flexibility	EPD	recyclable/extended producer resp.	biobased materials	FSC (for wood)	recycled content	sourcing of raw materials	material ingredient reporting	low emitting materials	lighting quality	acoustics
LOCATION DEPENDENT	PREMIUM OPTION	WITH INFILL PANEL										

VISUAL SELECTION

Item No.	Custom Slat Sizes Available			Slat Spacing (Nominal)	Dimensions Nominal W x L x H* (Inches)	
	W	H	Slats		Backer Only	Backer & Dowel Only
WOODWORKS® Grille – Classics Backer, Dowel, and Backer & Dowel Combination						
7263	5/8" W	1-3/8" H	6 slats	1-3/8"	12 x 96 x 1-7/8" Backer Only 12 x 96 x 1-3/8" Dowel Only	
7264	5/8" W	1-3/8" H	8 slats	7/8"	12 x 96 x 1-7/8" Backer Only 12 x 96 x 1-3/8" Dowel Only	
7265	5/8" W	2-1/4" H	6 slats	1-3/8"	12 x 96 x 2-3/4" Backer Only 12 x 96 x 2-1/4" Dowel Only	
7266	5/8" W	2-1/4" H	8 slats	7/8"	12 x 96 x 2-3/4" Backer Only 12 x 96 x 2-1/4" Dowel Only	
7091	5/8" W	3-1/4" H	5 slats	1-3/4"	12 x 96 x 3-3/4" Backer & Dowel 12 x 96 x 3-1/4" Dowel Only	
7092	5/8" W	3-1/4" H	6 slats	1-3/8"	12 x 96 x 3-3/4" Backer & Dowel 12 x 96 x 3-1/4" Dowel Only	
7093	5/8" W	4-1/4" H	5 slats	1-3/4"	12 x 96 x 4-3/4" Backer & Dowel 12 x 96 x 4-1/4" Dowel Only	
7094	1" W	2-1/4" H	4 slats	2"	12 x 96 x 2-3/4" Backer Only 12 x 96 x 2-1/4" Dowel Only	
7095	1" W	3-1/4" H	4 slats	2"	12 x 96 x 3-3/4" Backer Only 12 x 96 x 3-1/4" Dowel Only	
7096	1" W	4-1/4" H	4 slats	2"	12 x 96 x 4-3/4" Backer & Dowel 12 x 96 x 4-1/4" Dowel Only	
7097	1-1/4" W	3-1/4" H	3 slats	2-3/4"	12 x 96 x 3-3/4" Backer Only 12 x 96 x 3-1/4" Dowel Only	
7098	1-1/4" W	4-1/4" H	3 slats	2-3/4"	12 x 96 x 4-3/4" Backer & Dowel 12 x 96 x 4-1/4" Dowel Only	
7099	1-1/4" W	5-1/4" H	3 slats	2-3/4"	12 x 96 x 5-3/4" Backer & Dowel 12 x 96 x 5-1/4" Dowel Only	

PERFORMANCE

% Open Area	CleanAssure™ Disinfectable Panels		
	Fog	Spray	Wipe

69%	*	*	*
58%	*	*	*
69%	*	*	*
58%	*	*	*
74%	*	*	*
58%	*	*	*
74%	*	*	*
67%	*	*	*
67%	*	*	*
67%	*	*	*
69%	*	*	*
69%	*	*	*
69%	*	*	*

ACOUSTICAL INFORMATION

Performance determined by perforation size. Dots represent high level of performance.

Infill Panel Item No.	NRC
5823 or 6657	0.75

SUFFIX GUIDE

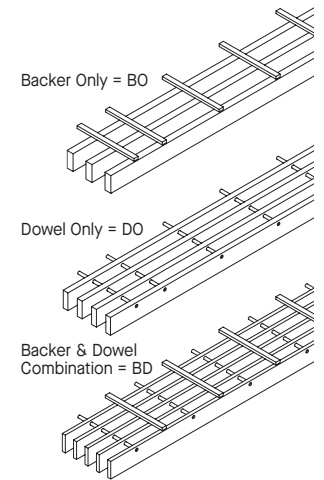

FAST134 program items ready to ship from manufacturer in 4 weeks or less. Up-to-date lead times and product options (sizes and colors) at armstrongceilings.com/fast134

- ◆ When specifying or ordering please include the installation type and color suffixes (e.g., 7092 B D G L C – 6 slats 3-1/4" Backer & Dowel in Light Cherry). Installation suffixes: BO = Backer, DO = Dowel, BD = Backer & Dowel Combination
NOTE: For additional color and size options, or curved applications options with flexible Backers (special order), call TechLine at 1 877 276 7876.
- * Actual panel length is 95"
NOTE: Panel backers are black. Custom backer colors available.



WOODWORKS® Grille – Classics

Solid Wood Ceiling Panels

Backer, Dowel, and Backer & Dowel Combination



Declare.

LEED WELL LBC

energy management	construction waste mgmt	regional materials	design for flexibility	EPD	recyclables/extended producer resp.	biobased materials	FSC® (for wood)	recycled content	sourcing of raw materials	material ingredient reporting	low emitting materials	lighting quality	acoustics
LOCATION DEPENDENT					PREMIUM OPTION					WITH INFILL PANEL			

For LEED contribution contact TechLine

ACCESSORIES

	Item No. ♦	Description	Dimensions Nominal W x L (Inches) Custom Sizes Available	Color	Pcs/ Ctn
Suspension Systems	7301	Prelude® XL® 12' HD Main Beam	15/16 × 144 × 1-11/16"	Black	20
	XL7341	Prelude XL 4' Cross Tee	15/16 × 48 × 1-11/16"	Black	60
	XL7328	Prelude XL 2' Cross Tee	15/16 × 24 × 1-3/8"	Black	60
Acoustical Infill Panels	5823	BioAcoustic™ Infill Panel	24 × 24 × 5/8"	Black Matte	12
	6657	BioAcoustic Infill Panel	11 × 48 × 5/8"	Black Matte	12
Accessories	5672 _ _ _	Junction - 1-3/8"	1-1/2 × 96 × 2"	All finishes	Bulk
	5674 _ _ _	End Cap - 1-3/8"	3/4 × 96 × 2"	All finishes	Bulk
	5675 _ _ _	End Cap - 2-1/4"	3/4 × 96 × 2-3/4"	All finishes	Bulk
	7170 _ _ _	End Cap - 3-1/4"	3/4 × 96 × 3-3/4"	All finishes	Bulk
	7171 _ _ _	End Cap - 4-1/4"	3/4 × 96 × 4-3/4"	All finishes	Bulk
	7172 _ _ _	End Cap - 5-1/4"	3/4 × 96 × 5-3/4"	All finishes	Bulk
	5687	Backer Clip	3/8 × 11/16 × 7/8"	N/A	250 pcs/pail
	5457GAL1 _ _ _	WoodWorks® Grille Solid End-Stain (Gallon)	N/A	All finishes	1 Gallon
	5457QT1 _ _ _	WoodWorks Grille Solid End-Stain (Quart)	N/A	All finishes	1 Quart
	5688	Dowel Clip	3/8 × 7/8 × 7/8"	N/A	250 pcs/pail
	5671 _ _ _	Ledger	1 × 96 × 1/4"	All finishes	Bulk
	7891	12-Gauge Soft Hanger Wire	144" Length	N/A	140
	6459BL	Uptight Clip	5-1/2" x 1-3/4"	Black	25
	RC2BL	RC2 Radius Clip	N/A	Black	205
	7239	Adjustable Trim Clip	-	N/A	50

♦ When specifying or ordering, include the 3-letter color suffix that coordinates with your WoodWorks ceiling: (e.g., 5671 G M P).
NOTE: For integration with Axiom® trim (Black recommended for use with Solid Wood).

WOODWORKS® – Standard

SUSPENSION SYSTEMS (Heavy-duty)

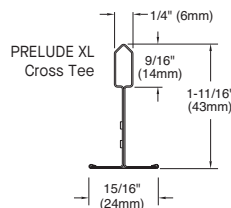
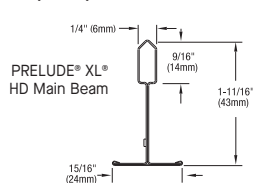

WOODWORKS® Grille – Classics

Solid Wood Ceiling Panels Backer, Dowel, and Backer & Dowel Combination



LEED WELL | LBC

For LEED contribution contact TechLine

energy management	construction waste mgmt.	regional materials	design for flexibility	EPD	recyclable/extended producer resp.	biobased materials	FSC® (for wood)	recycled content	sourcing of low materials	material ingredient reporting	low emitting materials	lighting quality	acoustics
LOCATION DEPENDENT					PREMIUM OPTION					WITH INFILL PANEL			

SYSTEM INSTALLATION DETAILS

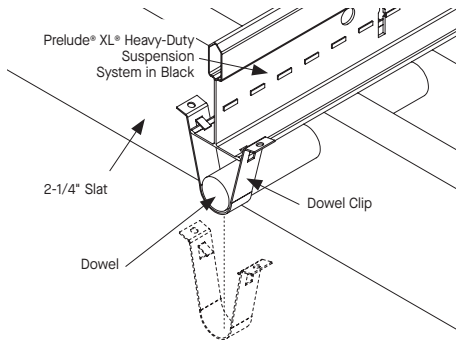

Ceiling Dowel Assembly

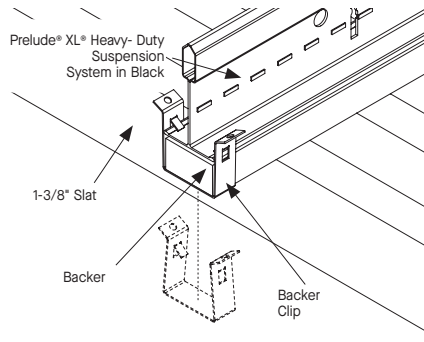

Ceiling Backer Assembly

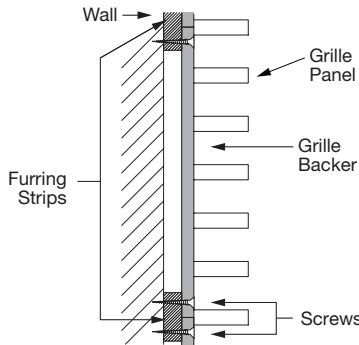

Wall Backer Assembly

Slat sizes over 2-1/4" are not recommended for wall applications. Contact TechLine for details at 1 877 276-7876.

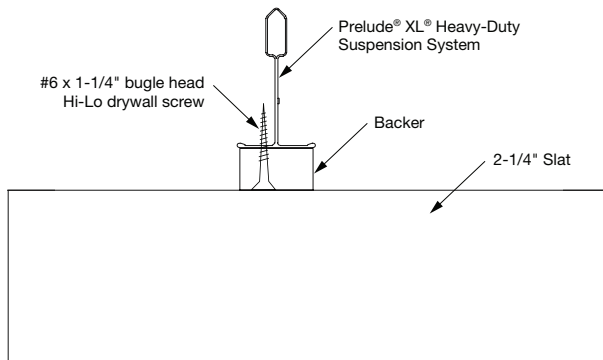

Screw Attachment Detail

NOTE: See WoodWorks® Grille installation instructions for details on faceted and seismic installations at armstrongceilings.com/woodworks

PHYSICAL DATA

Material
Dowel, Slats, Backers, and Tegular panels – solid Poplar.

Surface Finish
Clear or tinted semi-gloss coating on all finishes except White (GWH), which has a lacquer finish.

Fire Performance
Class C; ASTM E84 surface burning characteristics. Flame Spread Index 200 or less. Smoke Developed Index 450 or less.

Fire performance will vary between wood species.

Flame stop coating is available as a custom option. Contact ASQuote@armstrongceilings.com for details.

These panels, as with other architectural features located at the ceiling, may obstruct or skew the planned fire sprinkler water distribution pattern, or possibly delay or accelerate the activation of the sprinkler or fire detection systems by channeling heat from a fire either toward or away from the device. Consult a fire protection engineer, NFPA 13, and local codes for guidance where automatic fire detection and suppression systems are present.

Application Considerations
Variation among panels may occur due to the natural characteristics of the wood and grain.

Design Considerations

Custom slat and panel sizes available. For installations where slat alignment is critical, please see the WoodWorks Grille – Forté product line.

Backer & Dowel
For slat heights over 5", both dowels and backers are required for stability. Backer height is 1/2". Panel backers are black. Custom backer colors available.

Infill Panel Use
If no infill panel is used, unfinished parts of the suspension system and Axiom® trim will be visible from below.

Site Conditions
It is very important that panels are climatized prior to installation. Relative humidity between 25% and 55%, and temperatures between 50°F and 86°F, must be maintained.

Installation Consideration
When junction accessory is not used, the result will be a 1" gap between slat lengths.

Seismic Restraint
WoodWorks Grille – Classics panels have been engineered, tested, and approved for application in all seismic areas when installed per Armstrong Ceilings installation instructions.

Cleaning and Disinfecting
Cleaning and CDC approved disinfecting options available on armstrongceilings.com/cleaning

FAST134 Program Considerations

Size of Job Matters: Big jobs, over 2500 SF or 50 pieces for shapes/vertical elements will have longer lead times.

Location Matters: Transit time not included. We are ready to ship in 1 week on FAST1 items. However, transit to the states west of Wyoming may add time.

Distributor Truck Schedule Matters: We rely on distribution to help move products around the country. When speed matters, work with your local distributor to ensure FAST134 service.

Stock vs Made-to-Order Matters: FAST3 & FAST4 items are made-to-order and will ship direct to distributor. FAST1 (stocked items) will go through distribution and depend on distributor truck schedules.

Warranty
Details at armstrongceilings.com/warranty

Weight

7263	– 0.8 lbs/SF
7264	– 1.64 lbs/SF
7094	– 1.4 lbs/SF
7265	– 1.3 lbs/SF
7266	– 1.8 lbs/SF
7097	– 1.9 lbs/SF
7095	– 3.06 lbs/SF
7091	– 2.24 lbs/SF
7092	– 1.9 lbs/SF
7098	– 2.5 lbs/SF
7096	– 4.05 lbs/SF
7093	– 2.1 lbs/SF
7099	– 4.54 lbs/SF



LIGHTING SOLUTIONS

WOODWORKS® Grille – Classics

Linear Lighting

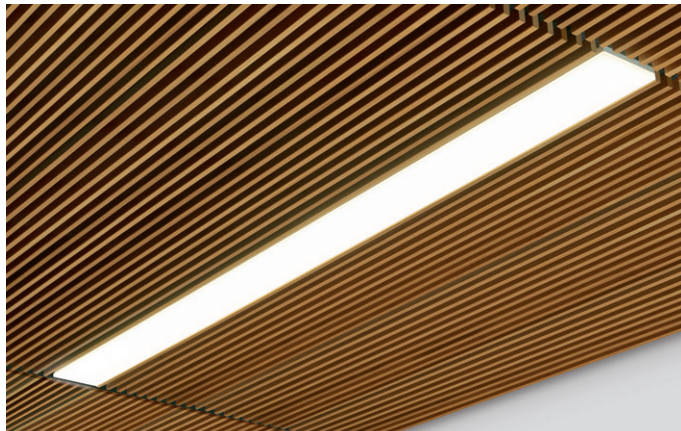

WoodWorks Grille – Classics panels in Maple with 5-1/4" x 95" linear light fixture

Seamlessly integrate linear light fixtures from Backlight® srl and XAL® with standard or made-to-order WoodWorks® Grille – Classics Backer-only panels using Integrated Light Connection Clips that suspend lights directly from the suspension system. This eliminates the need for independent support of the fixture or modification of the suspension system.



KEY SELECTION ATTRIBUTES

- Engineered and tested clip and suspension system seamlessly integrate lighting with grid
- Install lights seamlessly for WoodWorks Grille Backer Only Panels
- Low-profile, pre-engineered light fixture in coordinating 2", 3-1/4", and 5-1/4" widths from Backlight srl and XAL for a flush, sleek visual
- Approved for use in all seismic categories

DESIGN CONSIDERATIONS

- Length of lights are designed to coordinate with the length of panels
- Lights must run parallel with slat direction and are not for use in perimeter panels
- Reveal between light and slats will coordinate with the reveal from slat to slat
- Modified panels are required to leave outside slats intact (slats along edges cannot be removed)
- Coordination between ceiling contractor and electrician is required for installation

VISUAL SELECTION

Item No.	Description	Coordinating WoodWorks Grille – Classics Panel Item No.	Panel Field Modification Required*	Compatible Partner Light Fixture Dimensions W x L (Inches)	Clips Required per Light Fixture
WoodWorks Grille – Classics	 1-3/8" Integrated Light Connection Clip	7263BO	Remove 1 slat Remove 2 slats Remove 3 slats	2" x 95" 3-1/4" x 95" 5-1/4" x 95"	4 4 4
		7264BO	Remove 1 slat Remove 2 slats Remove 2 slats	2" x 95" 3-1/4" x 95" 5-1/4" x 95"	4 4 4
		7265BO	Remove 1 slat Remove 2 slats Remove 3 slats	2" x 95" 3-1/4" x 95" 5-1/4" x 95"	4 4 4
8171WGBOC02	 2-1/4" Integrated Light Connection Clip	7094BO	Remove 1 slat Remove 2 slats Remove 2 slats	2" x 95" 3-1/4" x 95" 5-1/4" x 95"	4 4 4
		7265BO	Remove 1 slat Remove 2 slats Remove 3 slats	2" x 95" 3-1/4" x 95" 5-1/4" x 95"	4 4 4
		7266BO	Remove 2 slats Remove 3 slats Remove 4 slats	2" x 95" 3-1/4" x 95" 5-1/4" x 95"	4 4 4
8171WGBOC03	 3-1/4" Integrated Light Connection Clip	7266BO	Remove 1 slat Remove 2 slats Remove 2 slats	2" x 95" 3-1/4" x 95" 5-1/4" x 95"	4 4 4
		7097BO	No modification Remove 1 slat Remove 1 slat Remove 1 slat	2" x 95" 2" x 95" 3-1/4" x 95" 5-1/4" x 95"	4 4 4 4

* Made-to-order panels that eliminate the need for field modification of standard panels are available via ASQuote@armstrongceilings.com
Contact ASQuote@armstrongceilings.com for Backer & Dowel and Dowel Only panels to be used with integrated lighting solutions.
NOTE: Items 8171WGBOC01, 8171WGBOC02, and 8171WGBOC03 are packaged 12 pcs/ctn

INSTALLATION DETAILS

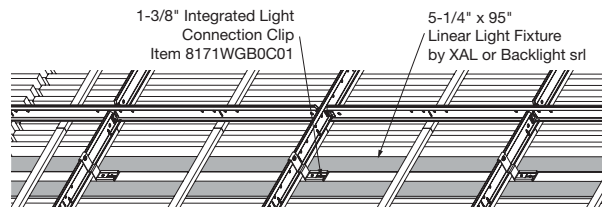
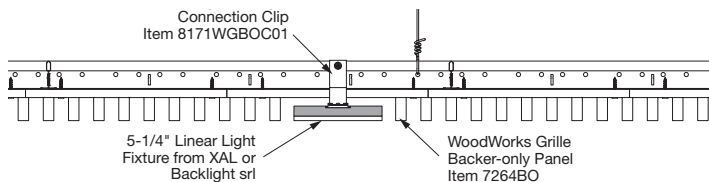

LIGHTING FIXTURES

Compatible with Backlight srl CHIARO light fixture and XAL® PANO Low-Profile Linear Plank light fixture



For detailed lighting information, contact your local Backlight srl or XAL® representative.



LIGHTING SOLUTIONS
WOODWORKS® Grille – Classics
 Downlighting

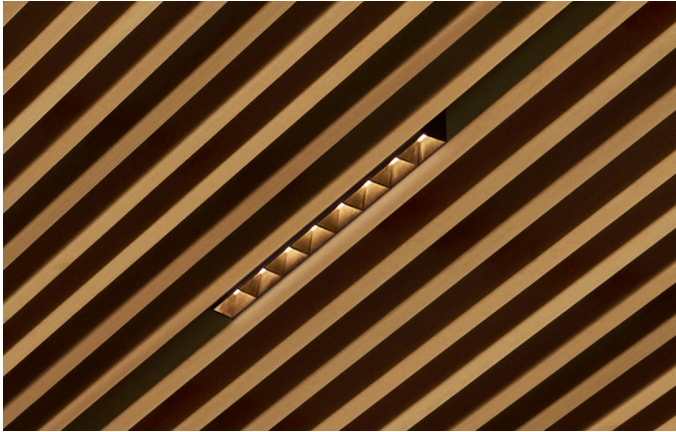

WoodWorks Grille – Classics panels with USAI Micro for WoodWorks – Vertical Slats light fixture

Seamlessly integrate downlight fixtures from USAI® Lighting with standard WoodWorks® Grille – Classics Backer & Dowel or Backer-only panels. Attach lights directly from the suspension system, eliminating the need for independent support of the fixture or modification of the suspension system.

KEY SELECTION ATTRIBUTES

- Engineered and tested to seamlessly integrate lighting fixtures with grid
- Install lights seamlessly for WoodWorks Grille – Classics Backer & Dowel and Backer-only Panels. Custom Dowel-only solutions are possible through ASQuote.
- USAI Lighting fixtures provide different downlighting styles for design flexibility
- Approved for use in all seismic categories

DESIGN CONSIDERATIONS

- Lights are designed to sit flush with the face of the WoodWorks panels
- Coordination between ceiling contractor and electrician is required for installation

WOODWORKS GRILLE – CLASSICS – Backer & Dowel and Backer-only Panels

WOODWORKS Panel Item No.	Slat Width	Slat Height	Open Area Between Slats	Slats Per Panel	Coordinating USAI Fixture Family	Coordinating USAI Fixture Part Numbers	USAI Grid Mounting Bar Item No.	USAI Trim Yoke and Centering Spacer Item No.
7091BD*	5/8"	3-1/4"	1-3/4"	5	Micro™ for WoodWorks – Vertical Slats (4 cell max)	MXGXX-VS	UA2	MXGVS-GL91
7093BD*	5/8"	4-1/4"	1-3/4"	5	Micro for WoodWorks – Vertical Slats (8 cell max)	MXGXX-VS	UA2	MXGVS-GL93
7096BD*	1"	4-1/4"	2"	4	Micro for WoodWorks – Vertical Slats (8 cell max)	MXGXX-VS	UA2	MXGVS-GL96
7098BD*	1-1/4"	4-1/4"	2-3/4"	3	Micro for WoodWorks – Vertical Slats (8 cell max)	MXGXX-VS	UA2	MXGVS-GL98
7099BD*	1-1/4"	5-1/4"	2-3/4"	3	Micro for WoodWorks – Vertical Slats (8 cell max)	MXGXX-VS	UA2	MXGVS-GL99
7094BO	1"	2-1/4"	2"	4	Micro for WoodWorks – Vertical Slats (8 cell max)	MXGXX-VS	UA2	MXGVS-GL94
7095BO	1"	3-1/4"	2"	4	Micro for WoodWorks – Vertical Slats (8 cell max)	MXGXX-VS	UA2	MXGVS-GL95
7097BO	1-1/4"	3-1/4"	2-3/4"	3	Micro for WoodWorks – Vertical Slats (8 cell max)	MXGXX-VS	UA2	MXGVS-GL97

NOTE: Refer to lighting partner cut sheets for light location considerations
 No panel field modification is required for USAI Micro light integration with WoodWorks Grille – Classics panels.
 *Trimming dowels is recommended for access, unless remote driver is used.

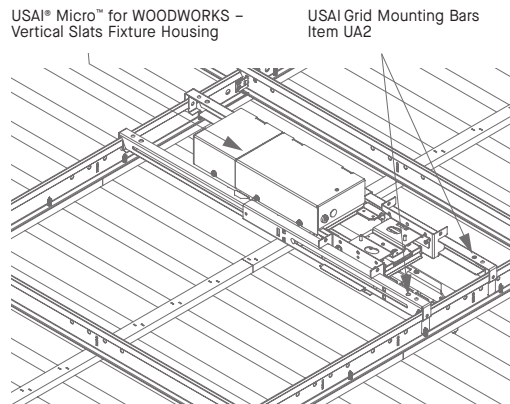
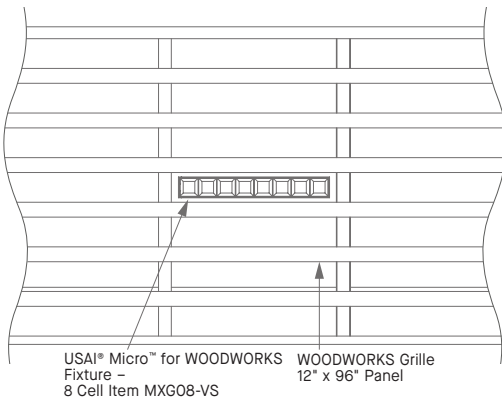

LIGHTING FIXTURES

Compatible with USAI Micro for WoodWorks – Vertical Slats lighting fixtures.

USAI®
 Lighting

For detailed lighting information, contact your local USAI Lighting representative.

