

METALWORKS™ Shapes for DESIGNFlex™ Tegular Panels

Assembly and Installation Instructions

This system is unique to the ceilings industry. Please completely read all instructions before beginning installation to avoid potential re-work.

Item #	Description	Ordered Separately/ Included with	Required for Install	Sold by the	Pcs/Ctn
Panels					
BP8284M1	METALWORKS™ 9/16" Tegular - 45° Triangle 48" Base	Ordered Separately	Based on Design	Pc	Bulk
BP8285M1	METALWORKS 9/16" Tegular - 45° Right Triangle 24" Base	Ordered Separately	Based on Design	Pc	Bulk
BP8287M1	METALWORKS 9/16" Tegular - 45° Right Parallelogram 48" Base	Ordered Separately	Based on Design	Pc	Bulk
BP8288M1	METALWORKS 9/16" Tegular - 45° Left Parallelogram 48" Base	Ordered Separately	Based on Design	Pc	Bulk
BP8290M1	METALWORKS 9/16" Tegular - 60° Triangle 24" Base	Ordered Separately	Based on Design	Pc	Bulk
BP8292M1	METALWORKS 9/16" Tegular - 60° Right Parallelogram 24" Base	Ordered Separately	Based on Design	Pc	Bulk
BP8293M1	METALWORKS 9/16" Tegular - 60° Left Parallelogram 24" Base	Ordered Separately	Based on Design	Pc	Bulk
BP8296M1	METALWORKS 9/16" Tegular - 60° Trapezoid 48" Base	Ordered Separately	Based on Design	Pc	Bulk
Suspension System Components					
Mains					
BP7500/BP7501	12' ID/HD Suprafine® Main Beam	Ordered Separately	Yes	Ctn	20
Cross Tees					
BPXL7520	2' Suprafine Cross Tees	Ordered Separately	Based on Design	Ctn	60
BPXM754524	Suprafine 45° Cross Tee - 24" Main Beam Spacing	Ordered Separately	Based on Design	Ctn	60
BPXM756024	Suprafine 60° Cross Tee - 24" Main Beam Spacing	Ordered Separately	Based on Design	Ctn	60
BPXM7524	Suprafine Perimeter Cross Tee - 24" Main Beam Spacing	Ordered Separately	Based on Layout	Ctn	60
Brackets					
BP75AB45D	Suprafine Double Angle Bracket 45°	Ordered Separately	Based on Design	Ctn	10
BP75AB45L	Suprafine Left Angle Bracket 45°	Ordered Separately	Based on Design	Ctn	10
BP75AB45R	Suprafine Right Angle Bracket 45°	Ordered Separately	Based on Design	Ctn	10
BP75CB45	Suprafine Corner Bracket 45°	Ordered Separately	Based on Design	Ctn	10
BP75AB60D	Suprafine Double Angle Bracket 60°	Ordered Separately	Based on Design	Ctn	10
BP75AB60L	Suprafine Left Angle Bracket 60°	Ordered Separately	Based on Design	Ctn	10
BP75AB60R	Suprafine Right Angle Bracket 60°	Ordered Separately	Based on Design	Ctn	10
BP75CB60L	Suprafine Left Corner Bracket 60°	Ordered Separately	Based on Design	Ctn	10
BP75CB60R	Suprafine Right Corner Bracket 60°	Ordered Separately	Based on Design	Ctn	10
	Bracket Screws, Nuts, Washers	Included with Brackets	Required for Angle Brackets	–	–
	1/2" Interior Metal Framing Screws*	By Contractor	Required for Corner Brackets	–	–

continued

continued

Item #	Description	Ordered Separately/ Included with	Required for Install	Sold by the	Pcs/Ctn
Perimeter Trim					
BP7800	Angle Molding	Ordered Separately	Based on Layout	Ctn	30
Varies	Axiom® Trim	Ordered Separately	Based on Layout	Pc	–
Accessories					
BPBERC2/BPFZBERC2	2" Beam End Retaining Clip	Ordered Separately	Based on Layout	Ctn	200/50
BPPAC	Perimeter Angle Clip	Ordered Separately	Based on Layout	Ctn	50
BPPCC	Axiom Perimeter Corner Clip	Ordered Separately	Based on Layout	Ctn	10

Reference Price List for min. order quantities.
See separate product Data Pages for additional information.
* Provided by contactor

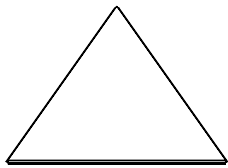

Triangle Panel

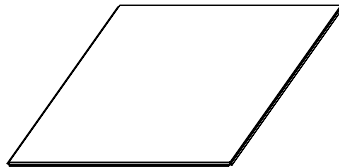

Parallelogram Panel

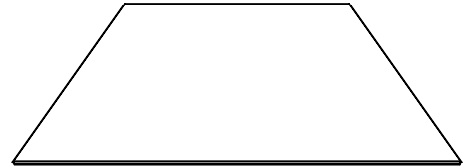

Trapezoid Panel

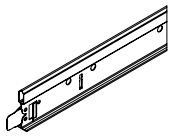

7501 Suprafine®
Main Beam

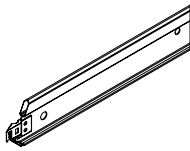

Suprafine XL
Cross Tee

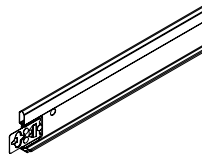

Suprafine XM
Cross Tee

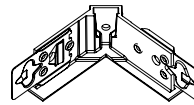

Double Angle
Bracket

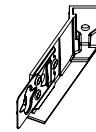

Left Angle
Bracket

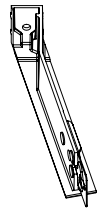

Right Angle
Bracket

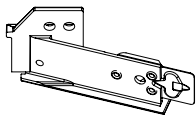

Corner
Bracket



BERC2



PMHDC

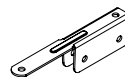

Perimeter Angle
Clip (PAC)

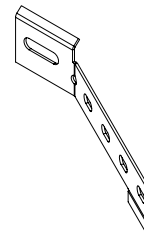

Perimeter Corner
Clip (PCC)



Screw and Nut
Assembly

1. GENERAL

1.1 Product Description

The METALWORKS™ Shapes for DESIGNFlex™ panels referenced in these installation instructions are made from aluminum with a factory-applied polyester coating. The panels come in eight distinct shapes, that can be mixed and matched to create interesting and dynamic patterns in the ceiling. See additional information about integrating lighting and diffusers at: armstrongceilings.com/designflex.

These panels are smooth and unperforated (M1) and available in four standard colors: Whitelume (WHA), Silverlume (SIA), Gun Metal (MYA), and Black (BL). Contact ASQuote@armstrongceilings.com to inquire about custom colors.

The panels have a square tegular stepped edge with a 5/16" drop. METALWORKS Shapes for DESIGNFlex Tegular panels are installed with standard Suprafine® main beams and molding. DESIGNFlex brackets and clips allow for 45-degree and 60-degree shapes. These panels can be installed with other DESIGNFlex Shapes panels, such as our Calla® Lyra®, Ultima®, or Optima® Shapes. Each layout will be based on parallel main beams, spaced at 2' on center (O.C.). Full-size panels are recommended for the field of the installation, while perimeter tees and clips are available to accommodate cut panels at the perimeter of the install.

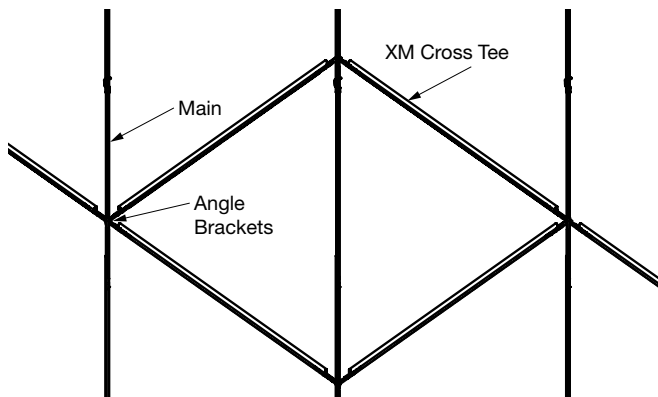

1.2 Storage and Handling

Ceiling panels shall be stored in a dry interior location and shall remain in their original crate prior to installation to avoid damage. When removed for install, the vertical panels should be stored in a flat, horizontal position. Proper care should be taken when handling to avoid damage or soiling.

NOTE: Each panel has a clear protective film on the surface of the panel to protect from dirt and scratching, as well as to indicate any directionality in the panel as noted by small arrows. The film should be removed after installation is complete.

1.3 Site Conditions

Areas to receive ceilings shall be free of construction dust and debris. Panels should only be installed in closed and acclimatized buildings. The METALWORKS Shapes for DESIGNFlex Tegular panels are not intended for exterior applications, where standing water is present, or where moisture will come in direct contact with the ceiling.

1.4 Fire Performance

METALWORKS Shapes panels are tested to ASTM E84 and CAN/ULC S102 surface burning characteristics. Flame Spread Index 25 or less. Smoke Developed Index 50 or less.

1.5 Safety Considerations

IMPORTANT SAFETY INFORMATION

- This is a custom design and installation.
- This product can't be installed in a sloped application.
- The final design and installation parameters are the responsibility of your design team.
- Project specific evaluation for compliance with building codes is recommended.
- Armstrong Ceilings has evaluated certain design configurations. Detailed instructions for those designs are available at the DESIGNFlex Shapes Pattern Gallery located at www.armstrongceilings.com/patterngallery.
- All information provided pertains solely to Armstrong® DESIGNFlex™ ceiling panels and components. Any ceiling panel, grid, component or accessory substitutions are not covered by these instructions or warranty.

1.5.1 Working with Aluminum Products

Product arrives in a crate; make arrangements for safe handling.

Edges of metal parts can be sharp. Handle metal carefully to avoid injury. Always wear safety glasses and cut-resistant gloves when handling or cutting metal.

When cutting panels, exposed raw edges of metal can be a safety hazard. Cutting tools should be appropriate for aluminum. Improper cutting equipment could damage or dent the metal panels and cause fit issues with the grid system.

1.6 Warranty

The METALWORKS Shapes for DESIGNFlex system has been tested based on the installation guidelines described in this document. The warranty will be voided if you do not follow instructions and guidelines.

1.7 Plenum

1.7.1 Installation of METALWORKS Shapes panels requires a minimum of 6" of space in the plenum.

NOTE: Light fixtures and air handling systems may require more space and may determine the minimum plenum height for the installation.

1.7.2 Independent support of MEP devices is required. There must not be weight from any lights, diffusers, speakers, or similar devices supported by mineral fiber or fiberglass Shapes panels. All such devices shall be independently supported.

1.8 Cleaning

An abrasive or strong chemical detergent should not be used. A mild detergent diluted in warm water, applied with a soft cloth, rinsed, and wiped off with a chamois will maintain the panels in good condition. Oily or stubborn stains, if not removed by washing, can be wiped with products like Fantastik®, but care is necessary to avoid affecting the gloss level of the paint finish.

2. DESIGN AND INSTALLATION CONSIDERATIONS

2.1 Layout

2.1.1 This system is designed to give maximum design flexibility while building off of 2' O.C. spacing of standard main beams. A mix of special length and standard length cross tees span between the mains at various angles. This can create an assortment of different shaped grid openings for panels. Refer to your job-specific drawings for layout and specific component locations.

2.1.2 Refer to the architectural ceiling plans (provided by others) for suspension system and panel orientation layout.

2.2 Directionality

2.2.1 Suspension System: Main beams are standard and are non-directional. Cross tees are also not directional and have the same stab connection on each end.

2.2.2 Panel Finishes: Panels are available in four standard colors: Whitelume (WHA), Silverlume (SIA), Gun Metal (MYA), and Black (BL). Silverlume and Gun Metal have slight directionality that might be visible in certain low-raking light conditions. Upon receipt, panels will have directionality marked by arrows on clear protective film.

2.2.3 Panel Shapes: All panels must be installed in a specific orientation in order to match the openings of the grid. The specified layout design will dictate the direction of the panels. Panels have a "base" side that runs parallel with the main beams. Because of this, all panels that are not right triangles, can only be installed in one orientation in relation to the main beam direction. Right triangle panels are the only shapes for which layouts can be designed with the panels quarter turned so that the "base" side is perpendicular to the mains.

This must be taken into consideration when designing an installation that mixes squares/rectangles.

2.3 Panel Offset

The finish face of the tegular panels drops 1/4" below the face of the grid.

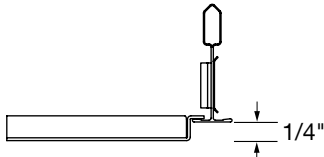

The installed height of components that interface with these ceiling panels, such as sprinkler heads and light fixture trim rings, will have to be adjusted to accommodate this 1/4" offset.

2.4 Plenum

2.4.1 All Shapes panels are lay-in type panels and require space in the plenum for installation.

2.4.2 A minimum of 6" above the grid is recommended for all installations. This will allow all panel sizes and shapes to be installed without damage.

2.5 Sprinklers

2.5.1 METALWORKS™ Shapes for DESIGNFlex™ Tegular panels drop 1/4" below the face of the grid. Sprinkler heads need to be installed at the proper height to accommodate this drop. See local building code officials or fire protection engineer when necessary.

Shapes installations can have an assortment of grid layouts resulting in some modules not having an opposite parallel side (triangles). Sprinklers that have brackets that attach to the grid (e.g. FlexHead® sprinklers) must attach to parallel mains.

2.6 Approximate System Weight

2.6.1 Overall system weight will be primarily based on the panel type. If mixing and matching Shapes panels from other product families, grid system must accommodate the heaviest panel. See DESIGNFlex Shapes Installation instructions for Mineral Fiber and Fiberglass panels for information.

- METALWORKS Shapes Tegular panels weigh 0.55 lbs/SF

2.6.2 The weight of the suspension system ranges between 0.2 – 0.4lbs/SF.

2.6.3 Hanger connections to the structure must follow the manufacturer's instructions and referenced code. Average system weight per square foot will vary based on panel types and layout.

2.7 Accessibility

2.7.1 Full size panels without penetrations are accessible. Border panels may not be accessible based on the perimeter interface and the installation method.

2.8 Perimeters

The way that perimeters are addressed will vary based on the design and layout within the space. These different methods for addressing the perimeters may require separate components and additional time to install compared to traditional installations.

2.9 Fixture Integration

Due to the non-standard grid openings that are created for the DESIGNFlex Shapes system, standard fixtures may not be compatible. For details on fixture integration through TechZone® layouts, and integration partners, see section 8.

2.10 Estimating

For guidance on estimating installed costs contact your Armstrong Ceilings Rep or Techline.

2.11 Seismic Installations

Ceiling areas over 1,000 SF must have horizontal restraint wire or rigid bracing. Engineering support or code officials should be consulted for spacing requirements. See section 9 for Seismic Installations.

3. ACCESSORIES

3.1 Suspension System Accessories

3.1.1 BERC2 clip

The BERC2 clip is used to secure grid to the wall molding without the use of pop rivets. When grid is interfacing the wall at an angle other than 90 degrees, the BERC2 can be field-modified to match angle of the grid.

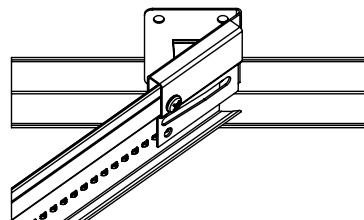

3.1.2 Axiom® Perimeter Corner Clip (PCC)

Installations that interface with Axiom may require the PCC based on the layout. This clip is used to connect grid to the Axiom trim where an angle change in the Axiom occurs. The PCC has a tab that can be cut to raise the grid 1/4" so that the cut edge of border panels can rest on the trim flange. Refer to section 5 for full instructions on integration of Axiom trims with Shapes installations.

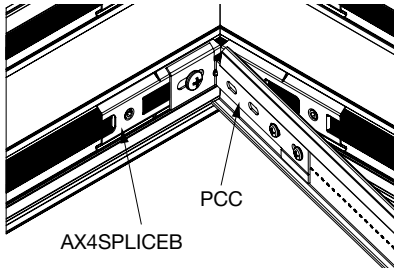

3.1.3 Perimeter Angle Clip (PAC)

The Perimeter Angle Clip is used when the layout has grid intersections occurring at the perimeter of the installation (i.e. layouts with full-size panels at perimeters). This clip allows a grid intersection to occur at the perimeter by connecting to a grid component already attached to the perimeter. The PAC is not compatible with the BERC2. When the PAC is required based on the layout, the typical BERC2 connection to the wall will have to be substituted for an XTAC or AS Universal HD Anchor (item 7100, seismic – unattached walls).

Refer to section 4.6 for PAC installation steps.

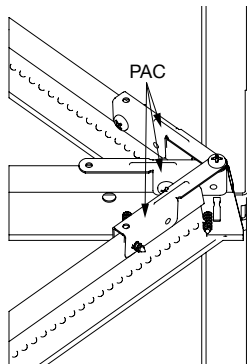

3.2 Panel Accessories

3.2.1 Maximum Hold Down Clips

Maximum Hold Down Clips (item PMHDC) are used in seismic installations on cut perimeter panels. See section 9 for more details.

4. SUSPENSION SYSTEM – WALL TO WALL

The requirements listed here represent the manufacturer's minimum acceptable installation recommendations, and may be subject to additional requirements established by the local authority having jurisdiction.

- All installations should follow ASTM C636.
- All references to suspension component duty ratings are per ASTM C635

4.1 System Components

- Main Beams:

METALWORKS Shapes for DESIGNFlex™ with Tegalur edge are installed on standard Intermediate-Duty Suprafine® main beams. See section 9 for grid requirements in seismic installations.

- Standard Cross Tees:

When standard cross tee items are required for a layout they must be Intermediate-Duty Equivalent (12 lbs./LF) or greater, and must be the same height as the main beams (1-11/16").

- Angle Brackets and Hardware

Angle Brackets are used to set the angles of the special length XM Cross Tees that span between the mains. These brackets are installed at rout hole locations along the mains and attached by a screw connection (hardware included). They feature a stab end detail for connection to the XM Cross Tees.

Fasteners are included in every carton of 10 angle brackets. These fasteners include 12 each of the following:

- Low-strength steel square nut (Zinc plated, 6-32 thread size)
- Steel-pan head Phillips screws (6-32 thread, 7/16" long)
- Zinc-plated steel SAE washer for #6 screw size (0.156" ID, 0.375" OD)

These are the only fasteners warranted for use with the angle brackets.

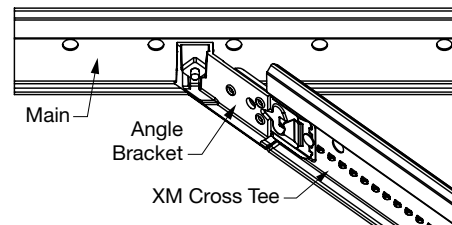

- Corner Brackets

Corner Brackets are used to connect XM Cross Tees into a 90-degree grid intersection. These are screw-attached through pre-drilled holes into the bulb of the intersecting grid component (screws provided by contractor). They feature a stab end detail for connection to the XM Cross Tees.

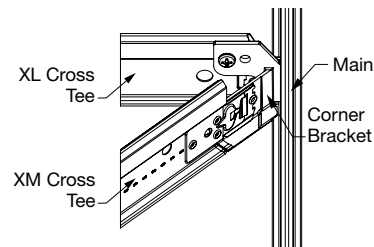

- XM Cross Tees

These cross tees are made to specific lengths and feature a stab end detail for connection to Angle or Corner Brackets.

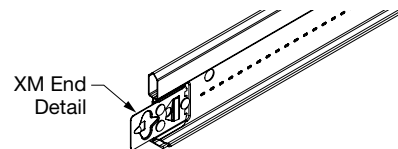

4.2 Suspension Rules

- Main beams must be installed at 24" O.C. per the layout drawing.
- Hanger wires must be installed on the mains within 24" of the perimeter and no more than 48" O.C. along the mains.

4.3 Layouts

The grid layout will be based on the Shapes design from the architectural ceiling plans/Technical Drawing Layouts. However, all possible layouts work off of 2' O.C. main beam spacing. Additionally, the standard 6" O.C. roud holes will line up between rows of mains as in a standard grid build.

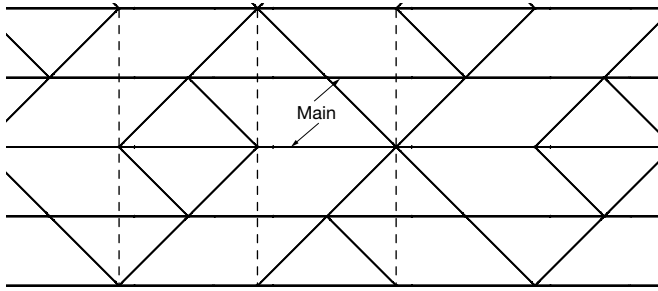

4.4 Squaring and Leveling the grid

Shapes installations cannot be squared by traditional means of measuring the diagonals of a grid opening. It is recommended to use a 90-degree laser or known perpendicular lines as control lines set up to run parallel with the mains and perpendicular through a matching row of roud holes. Alignment of the grid to the lines must be within 1/16" over 12'.

4.5 Order of Installation:

- Molding

Secure wall molding to the perimeter with the bottom flange at the finished ceiling height. The face of the grid will be installed 1/4" higher to account for the tegular drop. Refer to section 7.3 for further details.

- Hanging Points

Secure hanging points to the structure per the manufacturer's instructions based on the location of main beams and following the suspension rules in section 4.2. Cutting the tail of the wire wrap is recommended to help minimize interference or damage to panels during install.

- Mains

Hang main beams in the same manner as with a traditional grid installation. Stabilizer Bars (7425) can be used as temporary spacers to aid in squaring and aligning the mains in the absence of standard cross tees.

- XL Cross Tees (if applicable)

Install any standard cross tees that are perpendicular to the mains at this time to aid with spacing and aligning of the system. Any single cross tee connections must be addressed per the instructions in section 8.3.

- Angle Brackets (if applicable)

Attach the corresponding Angle Brackets to the mains per the locations specified in the drawings.

When two Angle Brackets occupy the same roud hole, a screw and nut are necessary to secure them back to back.

- Place one of the Angle Brackets with the tabs registering inside of the roud hole.

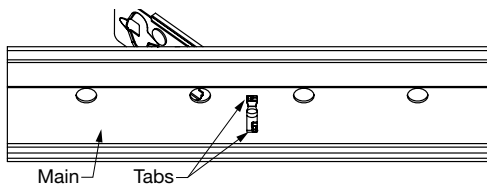

- Partially insert a screw from the front side to temporarily hold the bracket in place.

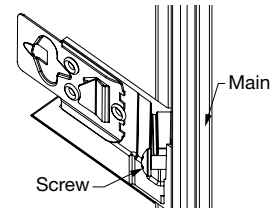

- Insert a nut into the slot of the second Angle Bracket and place the bracket back to back with the first bracket, with the tabs registering inside of the roud hole.

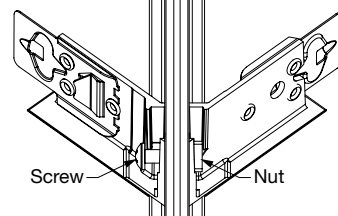

- Drive the screw in the first bracket until it pulls the two brackets tight against each other.

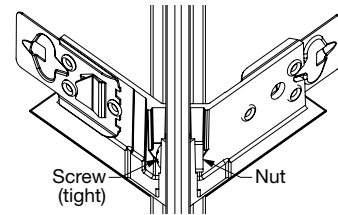

- The finished visual should have the overrides of the brackets flush with the main.

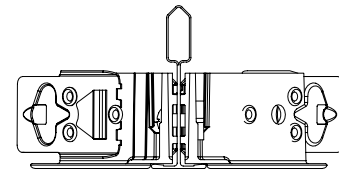
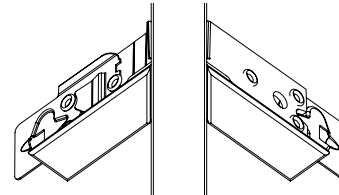

When only one Angle Bracket occupies a roud hole, a screw, washer, and nut are necessary to secure it.

- Insert a nut into the slot on the Angle Bracket and place the Angle Bracket with the tabs registering inside of the roud hole.

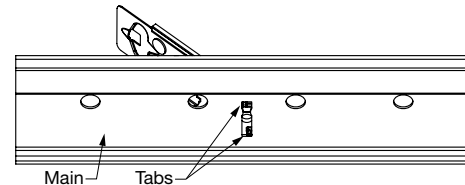

- While holding the bracket in place, insert a screw with a washer into the back side of the bracket.

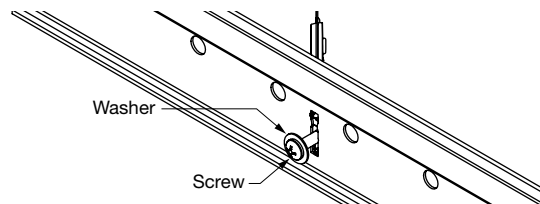

- Drive the screw until it pulls the bracket tight, with the override flush with the main.

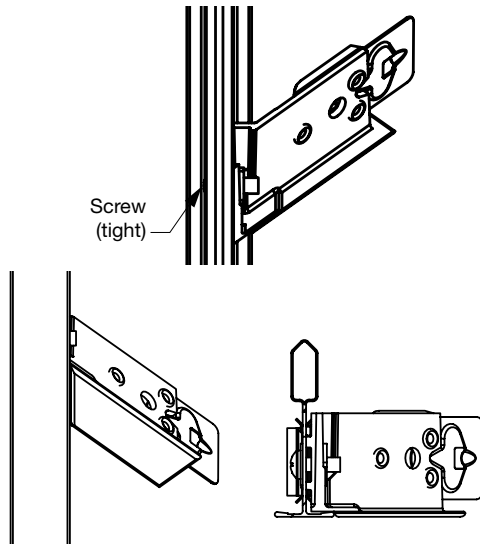

- Connect XM Angle Cross Tees

XM Angle Cross Tees are installed with a stab connection to the Angle Brackets. These connections are only compatible with the brackets, ensuring that all non-cut XM cross tees will connect to a bracket on both ends. Installations that create a truss-like layout may require a progressive/directional installation of the cross tees as the system will become very rigid as more cross tees are added.

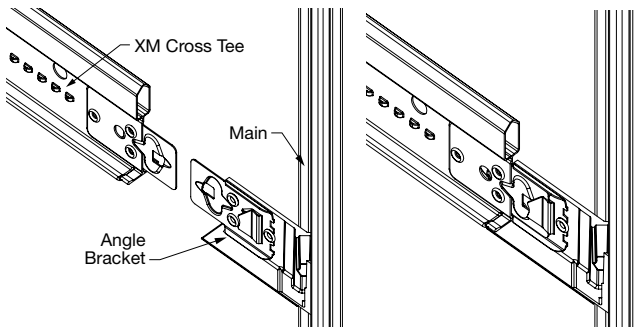

- Corner Brackets (if applicable)

To connect cross tees that require Corner Brackets:

- 1) Connect the XM end details of the Corner Brackets with the XM end detail of the XM Cross Tees.

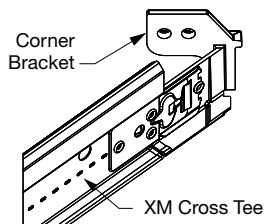

- 2) Place the cross tee into position, intersecting a 90-degree corner. The overrides on the Corner Bracket should be flush with main and XL cross tee.

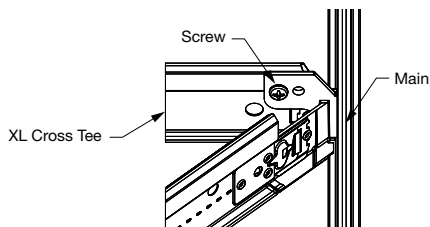

- 3) Clamp the Corner Bracket to hold in position during screw attachment.
- 4) Secure in place with a 1/2" framing screw through one of the pilot holes into the bulb of the adjacent grid.

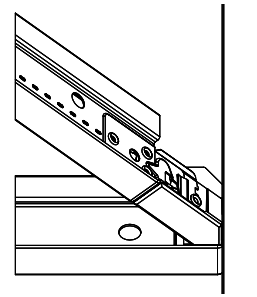

- The overrides on the Corner Bracket should be flush with main and XL cross tee.

4.6 Perimeter Attachment to Wall Molding

Special care should be taken with layouts that include grid intersections occurring at the wall due to the unevenness of typical wall conditions. For wall-to-wall installations, layouts with full-size panels at the perimeter should be avoided whenever possible. Installations with grid interfacing with wall molding should be installed with the grid raised 1/4" so that the face of the perimeter panels will rest on the molding.

All grid that interfaces with the perimeter must be secured to it.

As a result of having cross tees at angles other than 90° from the mains, the distance between where perimeter cross tees interface with the trim can vary (not a set 24" O.C.). This is based on the design layout, and distance/angle from the perimeter to the mains. Use of a string line or laser can help with laying out where cross tees will meet the perimeter.

- Main beams interface with the wall molding as in traditional installations and can be secured to the molding by GCWA or BERC2.
- Cross tees can be cut to length and secured to the wall molding with a BERC2 field modified to match the angle of the cross tee.

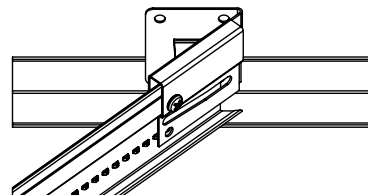

- Conditions where grid intersections occur at the perimeter will require the Perimeter Angle Clip. This clip allows a grid intersection to occur at the perimeter by connecting to a grid component already attached to the perimeter. Wall connections where the PAC will be used must be made with either the XTAC (non-seismic), or the AS Universal HD Anchor (seismic).

Installation Steps:

Intersections at mains or standard cross tees perpendicular to mains (90° grid to trim):

- Place a PAC over the bulb of the existing grid with the base side closest to the trim. Place so that the pilot hole on the top of the base end is located at the correct 6" O.C. increment to match the full-size panel dimension. (NOTE: with mains, the top pilot hole on the base will align directly above a rout hole). This PAC will provide a location that will act as the connection point for the intersecting grid members.

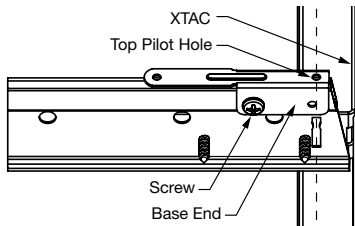

- Cut adjoining XM Cross Tees to length, ensuring that they will override the flange of the 90° grid and trim. Cut the face of the grid to match the angle that it interfaces with the 90° grid and trim.
- Place a PAC over the bulb of the cut XM Cross Tees so that the pilot hole on the flat side aligns over the top pilot hole on the base side of the previously installed PAC.

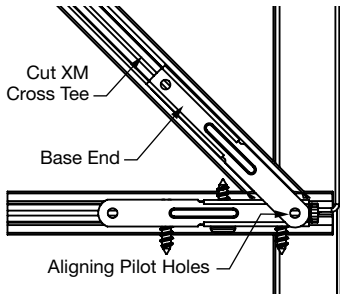

- Once the position has been verified, clamp the PAC to the cut XM Cross Tee and attach with one screw through the side of the clip and into the bulb.

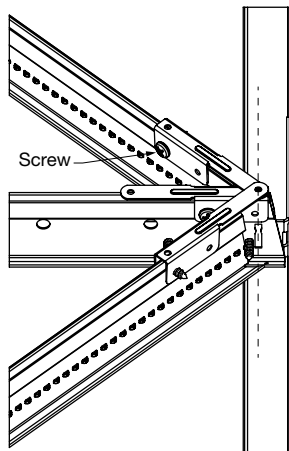

- Once all PACs have been screw-attached to XM Cross Tees, connect them to the first installed PAC by inserting a screw through the aligning holes on the top.

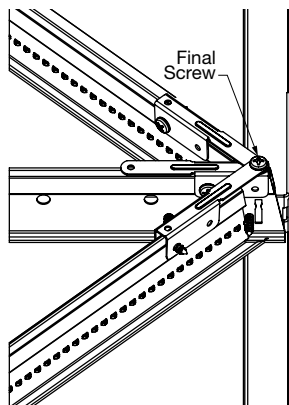

Intersections at XM Cross Tees parallel to mains:

- Place a PAC over the bulb of the existing cross tee with the base side closest to the trim. Place so that the pilot hole on the top of the base end is located at the correct 24" O.C. spacing for full-size panels. This PAC will provide a location that will act as the connection point for the intersecting grid member.

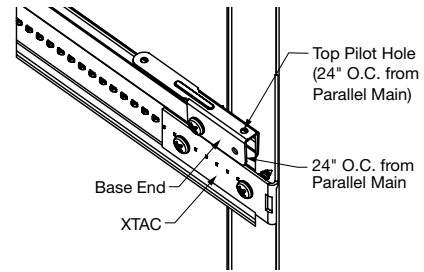

- Cut the adjoining XM Cross Tee to length, ensuring that it will override the bottom flange of the existing grid and trim. Cut the face of the grid to match the angle that it interfaces with the existing XM Cross Tee.
- Place a PAC over the bulb of the cut XM Cross Tee so that the pilot hole on the flat side aligns over the pilot hole on the base side of the previously installed PAC.

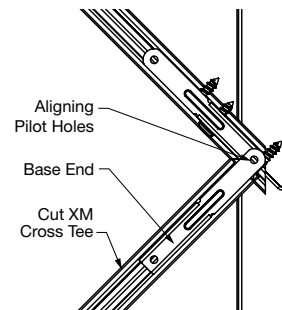

- Once the position has been verified, clamp the PAC to the cut XM Cross Tee and attach with one screw through the side of the clip and into the bulb.

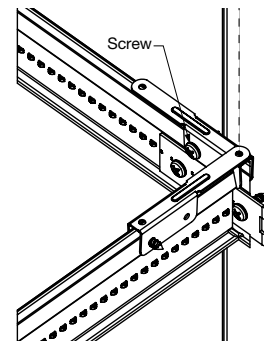

- Once the PAC has been screw-attached to the XM Cross Tee, connect it to the first installed PAC by inserting a screw through the aligning holes on the top.

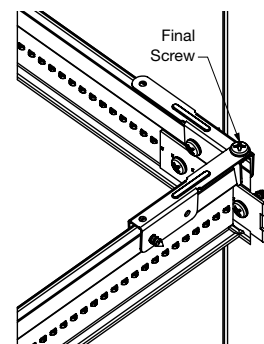

5. FLOATING PERIMETERS / TRIM FOR DISCONTINUOUS CEILINGS

Installations with Axiom® Trim are better for full-size panel designs and layouts as the overall dimensions of the install, and the angles of the trim can be controlled.

Layouts integrating Axiom must have grid intersections occurring directly at the trim (full-size panels) or have grid connections to the trim at least 1-3/4" O.C. apart (this is the minimum spacing between AXTBC clips).

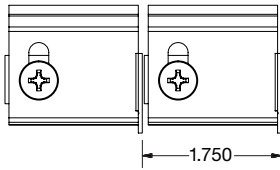

Refer to the installation instructions for the Axiom product you are using for instructions specific to the trim product. The following sections address rules in addition to the standard Axiom instructions that must be followed for integration with Shapes installations.

5.1 Suspension Rules

Based on the layout, this system may require additional suspension points when compared to the Axiom instructions for a traditional grid build.

In consideration of the suspension rules below, the Axiom can be independently supported to facilitate proper layout.

When the Axiom is not independently supported, the following suspension rules must be followed:

- All splices (including corners) must be supported by a connecting grid member within 24" on each side of the splice. Situations where there is no grid member that interfaces the trim within 24" of the splice will require supplemental support directly from the Axiom to structure.
- Axiom must be connected to supporting grid members no more than 48" O.C. Layouts in which grid does not interface the Axiom within 48" require supplemental supports directly from the Axiom to structure.
- All grid supporting the trim must have a wire at a max distance from the trim that is not greater than half the length of the grid member, up to a max of 12" (up to 8" in seismic installations).
- Refer to Axiom Classic instructions for additional installation requirements for Axiom 10" tall or greater.

5.2 Grid Attachment

- All main beams are attached to Axiom by the standard AXTBC connection.
- Single cross tees are attached to Axiom by screw-attachment to an AXTBC that is field-modified to match the angle of the cross tee.

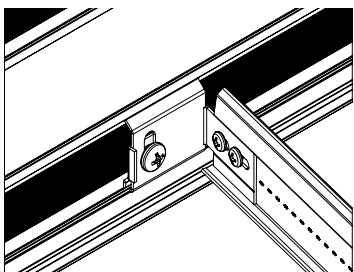

- Layouts where grid connects where there is an angle change (corner) in the Axiom will require the Perimeter Corner Clip (PCC). This clip can be used with inside corners and outside corners not less than 90° when attached to an existing AX4SPLICEB. The PCC is only compatible with the AX4SPLICEB, and cannot be used in conjunction with Corner Posts. It is installed by the following steps:

- Install the AX4SPLICEB at the corner location.
- Remove the second from the left hex head set screw.

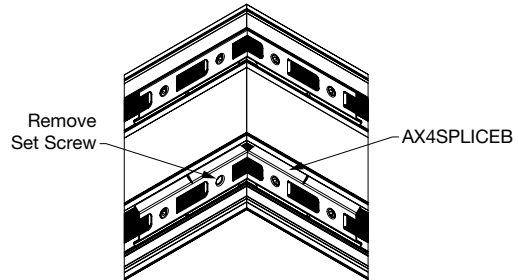

- Place the PCC at the corner location with the slot aligning with the now empty screw hole.

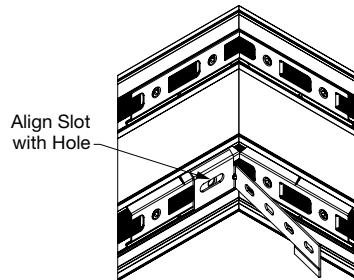

- Insert a screw from an AXTBC to secure the PCC in place. The slot allows for adjustment.
- Bend the arm of the PCC to match the angle of the grid.
- If the installation is not for full-size panels, cut the tab so that the grid can be raised 1/4".
- Clamp and attach the PCC to the grid with two screws.

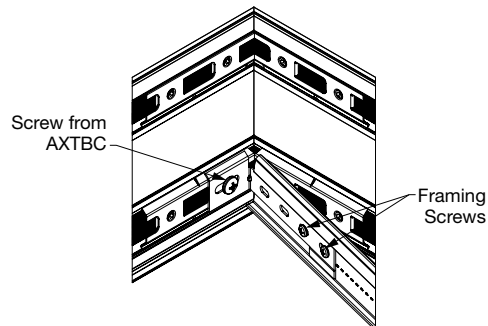

- Conditions where grid intersections occur at the perimeter will require the Perimeter Angle Clip (PAC). This clip allows a grid intersection to occur at the perimeter by attaching to a grid component already attached to the perimeter.

Installation Steps:

Intersections of XM Cross Tees at Mains or XL Cross Tees perpendicular to trim (90° grid to trim):

- Place a PAC over the bulb of the existing grid with the base side closest to the trim. Place so that the pilot hole on the top of the base end is located at the correct 6" O.C. increment to match the full-size panel dimension. (Note: with mains, the top pilot hole on the base will align directly above a rout hole). This PAC will provide a location that will act as the connection point for the intersecting grid members.

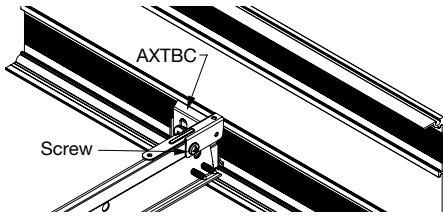

- Cut adjoining XM Cross Tees to length, ensuring that they will override the flange of the 90° grid and trim. Cut the face of the grid to match the angle that it interfaces with the 90° grid and trim.
- Place a PAC over the bulb of the cut XM Cross Tees so that the pilot hole on the flat side aligns over the top pilot hole on the base side of the previously installed PAC.

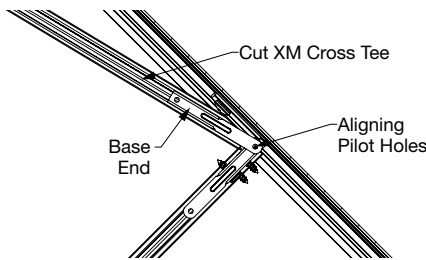

- Once the position has been verified, clamp the PAC to the cut XM Cross Tee and attach with one screw through the side of the clip and into the bulb.

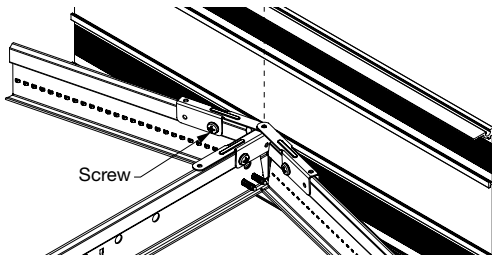

- Once all PACs have been screw-attached to XM Cross Tees, connect them to the first installed PAC by inserting a screw through the aligning holes on the top.

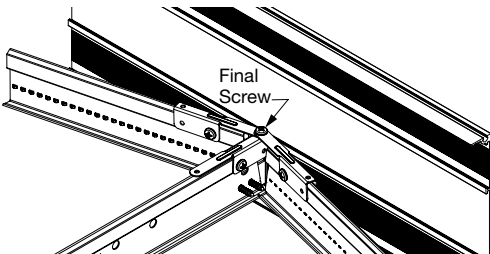

Intersections of XM Cross Tees Only (trim parallel to mains):

- Place a PAC over the bulb of the existing cross tee with the base side closest to the trim. Place so that the pilot hole on the top of the base end is located at the correct

24" O.C. spacing for full-size panels. This PAC will provide a location that will act as the connection point for the intersecting grid member.

- Cut the adjoining XM Cross Tee to length, ensuring that it will override the bottom flange of the existing grid and trim. Cut the face of the grid to match the angle that it interfaces with the existing XM Cross Tee.
- Place a PAC over the bulb of the cut XM Cross Tee so that the pilot hole on the flat side aligns over the pilot hole on the base side of the previously installed PAC.
- Once the position has been verified, clamp the PAC to the cut XM Cross Tee and attach with one screw through the side of the clip and into the bulb.
- Once the PAC has been screw-attached to the XM Cross Tee, connect it to the first installed PAC by inserting a screw through the aligning holes on the top.

6. TRANSITIONS

6.1 Using Axiom® Transitions

6.1.1 Suspension Rules

- Suspension of Axiom transitions must follow the same rules outlined in section 5.1 for Axiom trim.

6.1.2 Grid Attachment

- Grid attachment rules are to be determined based on floating perimeter attachment solutions.
- Grid attachment to Axiom transitions must follow the same rules outlined in section 5.2 Grid Attachment for Axiom Trim.
- All main beams are attached to Axiom transitions by the standard AXTBC or AXCCLT connection (refer to the Axiom Transitions instructions).
- Single cross tees are attached to Axiom transitions by screw attachment to an AXTBC or AXCCLT that is field-bent to match the angle of the cross tee.
- Conditions where grid intersections occur at the transition will require the Perimeter Angle Clip (PAC). This clip allows a grid intersection to occur at the transition by connecting to a grid component already attached to the transition. See section 4.6 for installation steps and details.

7. PANELS

METALWORKS™ Shapes panels are specifically designed for proper fit into Shapes grid openings. Cutting non-DESIGNFlex™ Shapes panels or other materials to fit into the grid openings is not recommended and not warranted.

7.1 Edge Details/Interface

METALWORKS Shapes for DESIGNFlex panels have a 5/16" regular edge detail that is supported on 9/16" Suprafine® grid.

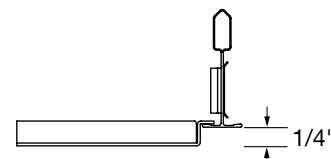

All tegular panels are for 9/16" Suprafine® grid only. The finish face of the tegular panels extends 1/4" below the face of the grid.

7.2 Directionality and Color/Finish Considerations

- Panel Finishes: Panels are available in four standard colors: Whitelume (WHA), Silverlume (SIA), Gun Metal (MYA), and Black (BL). Silverlume and Gun Metal have slight directionality that might be visible in certain low-raking light conditions. Upon receipt, panels will have directionality marked by arrows on clear protective film.
- Panel shapes: All panels must be installed in a specific direction based on matching openings in the grid while following the specified layout. Panels have a "base" side that runs parallel with the main beams. Because of this, all panels that are not right triangles can only be installed in one orientation in relation to the main beam direction. Right triangle panels are the only shapes for which layouts can be designed with the panels quarter-turned so that the "base" side is perpendicular to the mains.

7.3 Border Panels

Perimeter panels, less than full size, shall be neatly cut and installed by concealing the cut edge on the horizontal flange of a perimeter molding. Cut edges are held down from above with additional pieces of molding cut between the grid and the screw attached to the wall.

BERC2 clips are installed so that they hold the grid face 1/4" above the face of the molding by locking in the first set of lances on the molding hem. Once panels are cut to size and installed they must be held down with additional pieces of molding. These cut pieces of molding are pressed tight over the cut edge of the panel and screw-attached (framing screws provided by contractor) to the original molding.

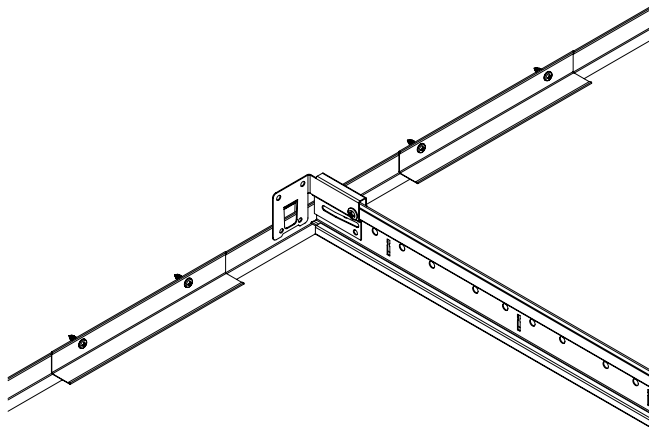

7.4 Cut Panels within the Field

7.4.1 Only full-size panels are permitted within the field of the installation. Penetrations can be made in panels following instructions in section 8, but panels cannot be field-cut to sizes that are not full module within the field. Instructions for the integration of MEP is addressed in section 8.1.

8. SPECIAL CONSIDERATIONS

8.1 Modifications to grid related to MEP

8.1.1 TechZone® Integration

TechZone is a recommended way to integrate linear fixtures into an Shapes system. This is achieved by building technical zones with mains that run parallel with the standard mains in the system.

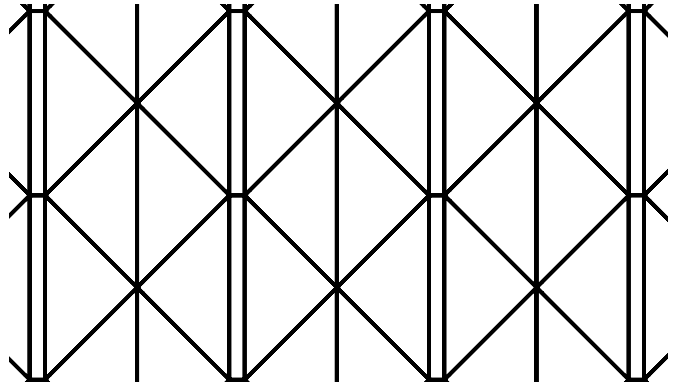

TechZone Limitations:

- When an Angle Bracket and TechZone cross tee are installed at the same rout hole location, the TechZone cross tee must be secured with a GC3W clip. This is because the screw connection for the Angle Bracket will occupy the rout hole and the XL end detail on the TechZone cross tee must be cut off.

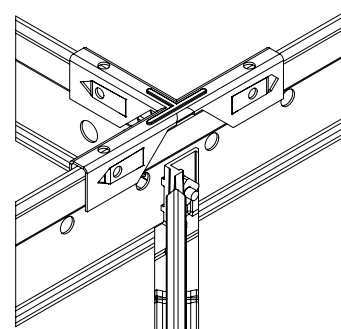
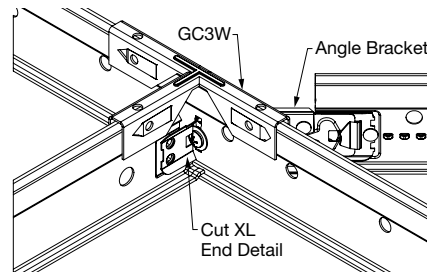

- Continuous fixture installations utilizing the TZYK cannot have Angle Brackets or Corner Brackets and the TZYK occupy the same rout hole.

8.1.2 Lights

Lighting Partners Integration:

Compatible lighting fixtures and drivers should be installed by a qualified electrician. Please refer to the lighting partner manufacturer (AXIS) for instructions. The suspension systems are designed and tested to support the weight of the light and driver. Subject to local code requirements for slack or additional support wires.

Standard Light Integration:

Shapes Panels installations can have an assortment of grid layouts resulting in some modules not having an opposite parallel side (triangles). This must be taken into consideration for light fixtures that require parallel grid components (e.g. bar hangers). Due to the variable grid layouts, it may be necessary to independently support all light fixtures.

8.1.3 Diffusers

Diffuser Partners Integration:

Compatible fixtures should be installed by a qualified mechanic. Please refer to the diffuser partner manufacturer (Price) for instructions. The suspension systems are designed and tested to support the weight of the diffuser and are subject to local code requirements for slack or additional support wires.

8.2 Slopes

Sloped installations of DESIGNFlex™ Shapes are not recommended or warranted.

8.3 Single Tee Insertion

8.3.1 Design layouts that include single cross tee insertions of XL end details (i.e. TechZone® layouts) will require use of the STAC or GC3W to secure the grid connection. Refer to STAC document for full instructions on the use of this clip.

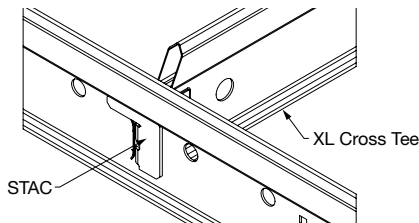

Use of ARPLUG is required where two Corner Brackets attach to the same cross tee and main intersection due to interference with the STAC. This will limit seismic application for layouts that require this.

8.4 Exterior Application

METALWORKS™ Shapes for DESIGNFlex Tegular panels are designed for interior installations only and cannot be installed in any exterior applications.

9. SEISMIC

9.1 General

For more details on Seismic installations please see our brochure: *Seismic Design: What You Need to Know*.

9.2 Suspension System

All seismic installations of Shapes panels must be installed per seismic design categories D, E, F due to the lack of perpendicular grid intersections. This is regardless of the total system weight. Heavy-Duty grid is required per ASTM E580.

9.2.1 Seismic Rx Cat C, D, E and F

- Ceiling installation should conform to basic minimums established in ASTM C636, with the following exceptions:
- Minimum 7/8" wall molding.
- Suspension system must be attached on two adjacent walls.
- Opposite walls require BERC2 and allow 3/4" movement at the wall.

- BERC2 maintains main beam and cross tee spacing; no other components required.
- BERC2 may need to be field-modified to match grid angles at the perimeter.
- Duty Rating of suspension systems are classified per ASTM C635.
- Safety wires required on light fixtures.
- Perimeter support wires within 8" of the perimeter angle.
- Ceiling areas over 1,000 SF must have horizontal restraint wire or rigid bracing. Engineering support or code officials should be consulted for spacing requirements.
- Ceiling areas over 2,500 SF should have separation by bulkhead or partition wall.
- Ceilings without rigid bracing must have 2" oversized trim rings for sprinklers and other penetrations.
- Changes in ceiling plane must have positive bracing.
- Cable trays and electrical conduits must be independently supported and braced.
- Suspended ceilings will be subject to special inspection.
- Special bracing may be required and should be specified by the seismic engineer on the project.

9.3 Perimeter Attachment

For wall-to-wall installations care should be taken with layouts that include grid intersections occurring at the wall due to the unevenness of typical wall conditions.

- Main beams interface with the wall molding as in traditional installations and are secured to the molding by the typical BERC2 connection.
- Cross tees can be cut to length and secured to the wall molding with a BERC2 field-modified to match the angle of the cross tee.

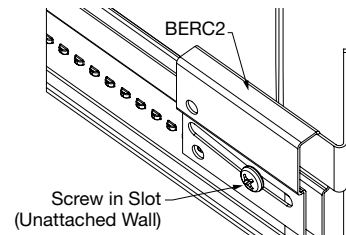

- Conditions where grid intersections occur over the flange of the perimeter trim will require the Perimeter Angle Clip (PAC) and the AS Universal HD Anchor (item 7100). This clip allows a grid intersection to occur at the perimeter by connecting to a grid component already attached to the perimeter. Because this clip connects cross tees to a grid component already connected to the perimeter (attached or unattached), it is always installed following the same steps.

Installation Steps:

Intersections of XM Cross Tees at Mains or XL Cross Tees perpendicular to wall (90° grid to wall):

- Secure the main or XL cross tee to the perimeter with the Universal HD Anchor, using a screw through the slot at unattached walls or a screw through a hole at attached walls. Place a PAC over the bulb of the grid with the base side closest to the perimeter. Place so that the pilot hole on the top of the base end is located at the correct 6" O.C. increment to match the full-size panel dimension. (Note: with mains, the top pilot hole on the base will align directly above a rout hole).

This PAC will provide a location that will act as the connection point for the intersecting grid members.

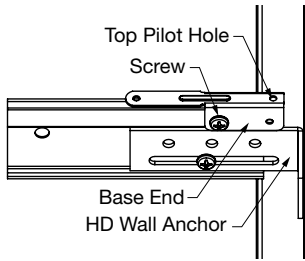

- Cut adjoining XM Cross Tees to length, ensuring that they will override the flange of the 90° grid and trim. Cut the face of the grid to match the angle that interfaces with the 90° grid and trim.
- Place a PAC over the bulb of the cut XM Cross Tees so that the pilot hole on the flat side aligns over the top pilot hole on the base side of the previously installed PAC.

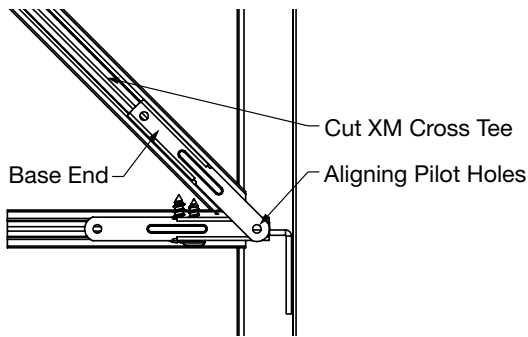

- Once the position has been verified, clamp the PAC to the cut XM Cross Tee and attach with one screw through the side of the clip and into the bulb.

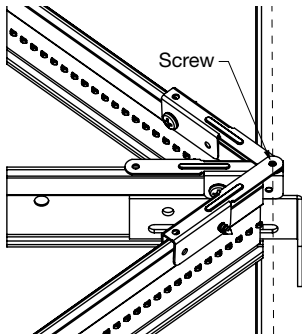

- Once all PACs have been screw-attached to XM Cross Tees, connect them to the first installed PAC by inserting a screw through the aligning holes on the top.

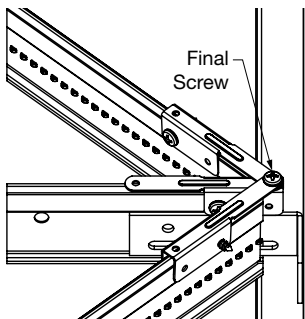

Intersections of XM Cross Tees Only (wall parallel to mains):

- Secure the first XM cross tee to the perimeter with the Universal HD Anchor, using a screw through the slot at unattached walls or a screw through a hole at attached walls. Place a PAC over the bulb of this cross tee with the base side closest to the perimeter. Place so that the pilot hole on the top of the base end is located at the correct 24" O.C. spacing for full size panels. This PAC will provide a location that will act as the connection point for the intersecting grid member.
- Cut the adjoining XM Cross Tee to length, ensuring that it will override the bottom flange of the existing grid and trim. Cut the face of the grid to match the angle that interfaces with the existing XM Cross Tee.
- Place a PAC over the bulb of the cut XM Cross Tee so that the pilot hole on the flat side aligns over the pilot hole on the base side of the previously installed PAC.
- Once the position has been verified, clamp the PAC to the cut XM Cross Tee and attach with one screw through the side of the clip and into the bulb.
- Once the PAC has been screw attached to the XM Cross Tee, connect it to the first installed PAC by inserting a screw through the aligning holes on the top.

9.4 Panel Installation

9.4.1 Perimeter Panels

Hold Down Clips (PMHDC) are required for perimeter panels. Maximum hold down clips must be placed one per every 2' of panel edges adjacent and opposite of the perimeter.

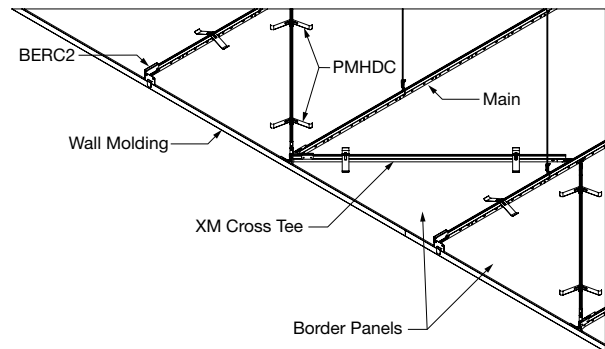

MORE INFORMATION

For more information, or for an Armstrong Ceilings representative, call 1 877 276 7876.

For complete technical information, detail drawings, CAD design assistance, installation information, and many other technical services, call TechLine customer support at 1 877 276 7876 or FAX 1 800 572 TECH.

For the latest product selection and specification data, visit armstrongceilings.com/shapes.

Inspiring Great Spaces® is a registered trademark of AFI Licensing LLC. The FlexHead® name and logo are trademarks of FlexHead Industries, Inc. Fantastik® is a registered trademark of S. C. JOHNSON & SON, INC. All other trademarks used herein are the property of AWI Licensing LLC and/or its affiliates.

© 2018 AWI Licensing LLC • Printed in the United States of America

BPLA-299061-518

